

 **BREAK FREE**®

SPEEDFEED®

 **KleenBore**™

B  **SQUARE**®



2011 PRODUCTS CATALOG



FIREARMS ACCESSORIES



FIREARMS



safariland.com/firearmsaccessories 800 347 1200





PRECISE, SUPERIOR PERFORMANCE FOR FIREARM MAINTENANCE

For decades these four legacy brands have made up the most honored names in the Firearms Accessories industry with products ranging from premium cleaning accessories and maintenance equipment to chemicals, polymer shotgun stocks and scope mounts. KleenBore™, SPEEDFEED®, Break Free® and B-Square® have been the proud products of our military, law-enforcement and sports shooting circles like no other brand names. Now united under the Safariland™ banner, our accessories are the overwhelming choice around the world. And for good reason. As always, we work hard to build on the unique leadership position we have earned, offering the industry's most extensive range of top products. We have combined our renowned legacies of innovation, quality and customer care to provide genuine one-stop shopping for every type of firearm accessory you need. Today's Safariland™ remains totally committed to the avid sportsmen and to serving those who put it all on the line to uphold order and keep the peace.

AR-15 ACCESSORIES	5
BASES & MOUNT SYSTEMS	6
SCOPE RINGS	10
TACTICAL & LAW ENFORCEMENT	11
CLEANING KITS	15
FIELD PACK KITS	18
SPECIALTY KITS	19
SAF-T-CLAD® RODS	20
CLEANING RODS	21
TOOLS & ACCESSORIES	23
CLEANERS & SOLVENTS	34
LUBRICANTS & PROTECTANTS	36





3

FIREARMS ACCESSORIES — BRAND INTRODUCTION



OVER 50 YEARS OF EXPERIENCE IN GUN MAINTENANCE

Safariland features Classic and Specialty cleaning kits by KleenBore™ made of the best cleaning components in the industry for rifles, handguns and shotguns. Our kits are backed by over 50 years of experience and are the favorite of hunters, law enforcement and the military. Quality products that are compact, and easy to carry, in the field or on the range. You get fast and easy removal of impacted mud, snow or a squib load. Our products are also backed by a limited lifetime warranty.

THE UNDISPUTED CHOICE FOR SHOOTERS WHO EXPECT PRECISION

Safariland Firearms Accessories products from KleenBore and SPEEDFEED are the result of technological breakthroughs for the ultimate in performance. The Saf-T-Clad® epoxy thermal-setting resins are applied on high-grade, solid steel rods that provide a securely bonded coating. This process provides an unbelievably smooth surface for the ultimate in rifling and bore protection. The undisputed choice for shooters who expect absolute precision from their equipment. SPEEDFEED stocks are poured thicker with 30-percent glass-filled resin so the stocks maintain their integrity with heavy use, performing even under serious pressure.



SAFARILAND

ORIGINALLY DEVELOPED FOR THE U.S. MILITARY'S EXTREME CONDITIONS

What makes our CLP® better? In 1971, the U. S. military sought a new product to improve weapon performance in the world's most challenging environments. They issued a set of criteria that came to be known as the "impossible specification". They only found one product to meet that standard: BreakFree® CLP®.

- It has been proven to perform in temperatures ranging from -65° F to +475° F and after saltwater immersion
- It is manufactured from the highest-quality polymerized synthetic oils plus friction-reducing anti-wear additives
- It reduces metal-to-metal wear by layering surface areas with an advanced boundary film
- It does not degrade under high temperatures and extreme pressure. Other brands may contain wax-based materials that will degrade and solidify into a gummy residue
- It displaces and loosens residue and contaminants from bearing areas
- It protects metals with special rust inhibitors

KNOWN WORLDWIDE FOR INNOVATION IN MOUNTING SYSTEMS

B-Square® is the industry standard in scope mounts and rings. Scope mounts for sporting rifles require no gunsmithing and install in minutes. The quick-detach mounts have return-to-zero capability and sport extra-long ring mount rails to achieve maximum eye-relief adjustments. The B-Square no-gunsmithing, semi-auto pistol mounts integrate with the pistol's original components to assure optimum performance with every trigger-pull and are superior to any grip-mounted system. B-Square Shotgun Saddle mounts are the industry leaders for mounting optics on shotguns without having to use a gunsmith. Innovative designs by B-Square provide a convenient, secure and stable platform.



4

FIREARMS ACCESSORIES — BRAND INTRODUCTION



SAFARILAND

safariland.com/firearmsaccessories 800 347 1200

AR-15 ACCESSORIES

AR-15 MOUNTS



SAF-S30 Single Ring Mount

- 30mm tube diameter
- Designed for 30mm red dot sights requiring single ring mounting
- SAF-S30 is wider at the base than the mounting ring
- Provides maximum stability and strength for attaching to the receiver
- SAF-S30FDE Flat Dark Earth color option



SAF-S30C Single Ring Mount Cantilever

- 30mm tube diameter
- Single ring mount cantilevered forward to enable the use of night vision or magnifiers
- Receiver mounting base is wider than the mounting ring
- Provides maximum stability and strength for attaching to the receiver
- SAF-S30CFDE Flat Dark Earth color option



SAF-D30 Double Ring Mount

- 30mm tube diameter
- Designed for use with telescopic sights
- SAF-D30 has two rings integral within the mounting base
- A single clamp is secured by two MIL-SPEC thumb knobs to maximize strength and rigidity
- The forward ring is cantilevered to allow for maximum eye relief
- SAF-D30FDE Flat Dark Earth color option



TACTICAL ACCESSORIES



TAC-0007 AR-15/16 Flat Top Riser

- Fits all Flat-Top AR-15s and similar
- True Picatinny design
- Fits all standard dovetail and Picatinny rails



BASES & MOUNT SYSTEMS

CLASSIC MILITARY MOUNTS



18561 Mauser 98 (German) Scout Mount

- Replaces rear sight leaf
- Elevation adjustment so any LER (pistol) scope can be used without a change in zero
- Standard dovetail base
- Includes 1" ring



18477 Springfield 1903

- Replaces the gun's magazine cut-off
- See-under mount allows use of gun's sights
- Quick on and off with no change in zero
- Windage and elevation adjustments
- Includes 1" rings

CLASSIC MILITARY MOUNTS (includes 1" rings)

18564 SMLE MK 1 #4, #5 (rec mount)

18554 Springfield M-1 Garand (rec mount)

MODERN MILITARY MOUNTS



18526 Colt AR-15/16 See-Thru Carry Handle Mount

- Attaches to the gun's handle with a large thumb screw knob
- Return to zero capabilities
- Standard dovetail base
- Black matte only



15150 Colt AR-15/16, M16 Flat Top w/ integral rings

- Base complete with 1" integral rings
- Attaches to gun's dovetail by large thumb screw knobs
- Return to zero capabilities
- Raises the scope over the front sight
- Fits Weaver® style and Picatinny rails



18513 Heckler & Koch 91/93/94/MP5

- Snaps over the gun's receiver
- Locks with a single knob
- Strengthened side-plates and clamp knobs
- Standard dovetail base
- Includes 1" rings



18600 AK-47/MAK-90

- Receiver mount for Chinese models
- Attaches using steel trigger bolt & hammer-bolt (included)
- Standard dovetail base
- Includes 1" rings

MODERN MILITARY MOUNTS (includes 1" rings)

18500 FN-FAL / LAR / L1-A1 (replaces cover)

18500 Springfield SAR 8, SAR 48, SAR 4800

18514 Springfield M-1A, M14 (receiver mount)

B-SQUARE



6

B-SQUARE — BASES & MOUNT SYSTEMS

800 347 1200

safariland.com/firearmsaccessories



SEMI-AUTO PISTOL MOUNTS



42214 Browning Buckmark .22 Universal

- Attaches by removing two screws and replacing rear sight base
- Standard dovetail base
- Multiple slots for eye relief
- Black matte only



42878 Ruger MK I/II Universal

- For non-drilled Ruger MK I and MK II only
- Slides onto receiver
- See-under mount allows use of gun's sights
- Return to zero capabilities
- Standard dovetail base
- Stainless steel finish

42877 Black Matte Finish

REVOLVER MOUNTS



42406 Smith & Wesson Universal Mount

- Uses rear sight recess for recoil stop and mount attachment
- Fits all K, L, N frames
- Fits all calibers and 5" barrel lengths and longer
- Available for both pre- and post-1993 revolvers
- Stainless steel finish
- 42405 Black Matte finish

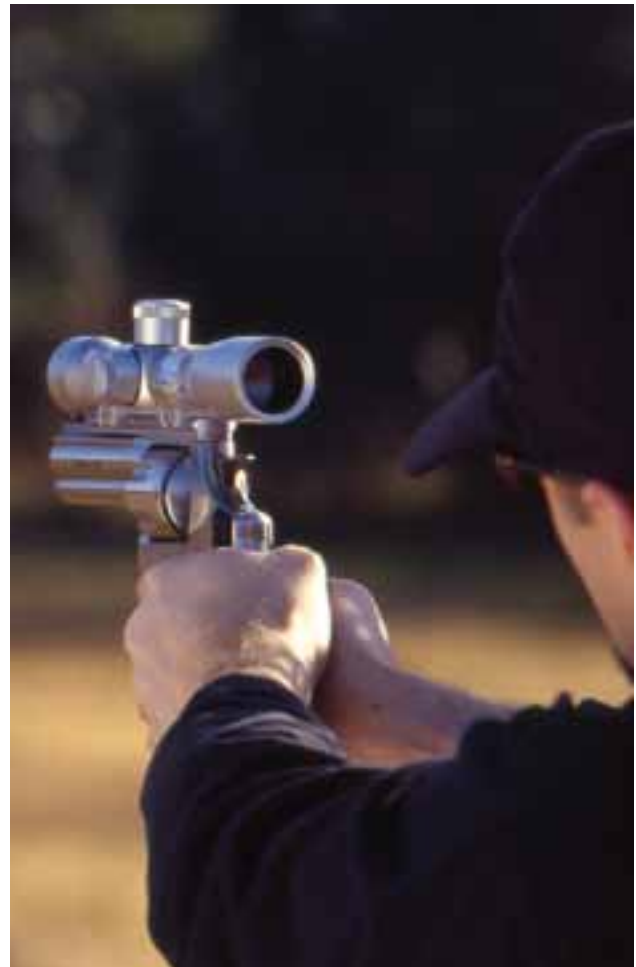

REVOLVER MOUNTS (rings not included)

BLACK MATTE FINISH

42405 Rossi 971 non vent rib model only 6" non-ported barrel

STAINLESS FINISH

42406 Rossi 971 non vent rib model only 6" non-ported barrel

42974 Ruger GP 100 Rib Mount 6" non ported

42306 Taurus .44 Magnum, 607, 608 6" & 8" barrel with vent rib

SHOTGUN SADDLE MOUNTS

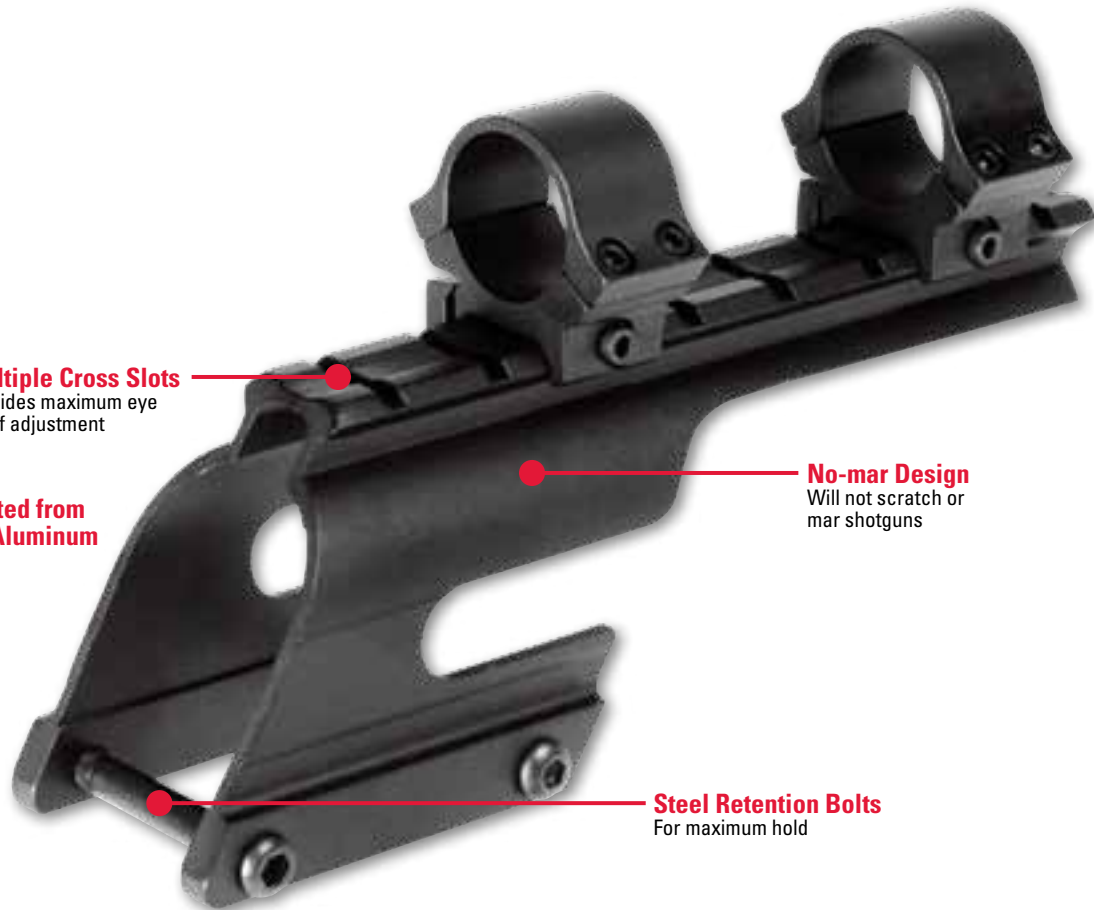

Multiple Cross Slots
Provides maximum eye relief adjustment

Constructed from Aircraft Aluminum

No-mar Design
Will not scratch or mar shotguns

Steel Retention Bolts
For maximum hold

- 16600** Baikal 153 series Semi-auto 12-Gauge
- 16305** Benelli Nova 12-Gauge
- 16330** Benelli Super Black Eagle 12-Gauge
- 16300** Benelli Super 90 12-Gauge/ Benelli Montefeltro 12-Gauge
- 16205** Browning A-5 12-Gauge
- 16212** Browning Gold 12-Gauge
- 16337** Ithaca 37, 87 12-Gauge
- 16500** Maverick 88 12-Gauge
- 16585** Maverick 91 12-Gauge
- 16500** Mossberg 500 12-Gauge
- 16585** Mossberg 535/835 12-Gauge
- 16800** Remington 1100, 1187 (12, 16 & 20-Gauge w/ serial X/N)
- 16812** Remington 870 (12 & 20-Gauge w/serial X/N)

- 16812** Remington 870 Express 3.5" mag
- 16820** Remington 870 20-Gauge Express LT
- 16825** Remington 1100 20-Gauge Semi-auto LT
- 16900** Winchester/USRAC 1200, 1300, 1400, 1500 12-Gauge
- 16212** Winchester Super X2 31/2 Mag



- 16800MB** Remington 870 SPS & SPS-T 12-Gauge & Super 16812MB Magnum
- 16812MB** Remington 870 (12 & 20-Gauge w/ serial X/N), 870 Express 3.5" mag



16175 Universal Cantilever Mount

- Rings not included
- Ribs up to 3/8"

Mossy Oak is a registered trademark of Haas Outdoors, Inc., West Point, MS. and is used with permission



8

B-SQUARE — BASES & MOUNT SYSTEMS

800 347 1200

safariland.com/firearmsaccessories



PRECISION AIRGUN MOUNTS



17015 Dovetail to Picatinny Adaptor

- Works with any factory issue dovetail rail
- Picatinny design for more diverse mounting options
- Cantilevers forward or backward for correct eye-relief
- Easy Installation



17025 3/8" to Weaver® Adaptor

- 2-piece base
- Rings not included



17021 11mm to Weaver® Adaptor Riser with Elevation

- Attaches to any 11mm dovetail
- Easy installation

SCOPE RINGS

INTERLOCK™ RINGS

- B-Square® unique, wraparound design
- Exceptional clamping strength
- Steel recoil key for magnum use
- Hex key included



BLACK MATTE FINISH

- 10039** 1" x 11mm Dovetail
- 10042** 1" x Standard Dovetail with recoil blade
- 10045** 30mm x 11mm Dovetail with recoil blade
- 10048** 30mm x Standard Dovetail with recoil blade

STAINLESS FINISH

- 10043** 1" x Standard Dovetail with recoil blade

SPORT UTILITY RINGS

- Wraparound design
- Lightweight, affordable strength
- Maximum scope retention and twice the clamping area
- Hex-key included



LOW BLACK MATTE FINISH

- 20052** 1" x Standard Dovetail
- 20062** 30mm x Standard Dovetail
- 27052** 1" x 3/8" Dovetail

LOW STAINLESS FINISH

- 20053** 1" x Standard Dovetail
- 20063** 30mm x Standard Dovetail



MEDIUM BLACK MATTE FINISH

- 20054** 1" x Standard Dovetail
- 20064** 30mm x Standard Dovetail
- 27054** 1" x 3/8" Dovetail
- 27064** 30mm x 3/8" Dovetail

MEDIUM STAINLESS FINISH

- 20055** 1" x Standard Dovetail
- 20065** 30mm x Standard Dovetail
- 27055** 1" x 3/8" Dovetail
- 27656** 30mm x 3/8" Dovetail

HIGH BLACK MATTE FINISH

- 20056** 1" x Standard Dovetail
- 20066** 30mm x Standard Dovetail
- 27056** 1" x 3/8" Dovetail
- 27066** 30mm x 3/8" Dovetail

HIGH STAINLESS FINISH

- 20067** 30mm x Standard Dovetail
- 20057** 1" x Standard Dovetail
- 27057** 1" x 3/8" Dovetail
- 27067** 30mm x 3/8" Dovetail

EXTENSION RINGS

- 21052** Low Weaver
- 26052** Low 1" x 3/8" Dovetail Rimfire/Airgun
- 21054** Med Weaver
- 26054** Med 1" x 3/8" Dovetail Rimfire/Airgun
- 21056** High Weaver
- 26056** High 1" x 3/8" Dovetail Rimfire/Airgun

TACTICAL & LAW ENFORCEMENT

SPEEDFEED® I STOCK SETS

- Magazine tubes store a total of four 2.75" rounds, two on each side
- Steel spring in each tube holds rounds securely until needed
- Stored shells instantly available for loading with the flick of a finger
- Set includes stock, forend and recoil pad



0100 Remington 870 12-Gauge



0103 Remington 1100 12-Gauge



0102 Remington 11-87 12-Gauge



0115 Mossberg 500/590 12-Gauge



0116 Winchester 1200/1300 12-Gauge



0100CAT Remington 870 12-Gauge



0100CFDE Remington 870 12-Gauge



0100CMC Remington 870 12-Gauge

SPEEDFEED



11

SPEEDFEED — TACTICAL & LE STOCKS

800 347 1200

safariland.com/firearmsaccessories

SPEEDFEED® II STOCK SETS

- Crafted with 30% glass-filled polymers, this rugged stock will remain dependable in all situations
- Molded from our special polymer formulation
- Available for Remington® 870 12-gauge
- Stock pistol grip features pebbled-grain finish for a sure, solid grip every time
- Comes complete with ribbed forend and recoil pad



SPEEDFEED® III STOCK SETS

- Pistol-grip design gives true one-hand control
- Magazine tubes store a total of four 2.75" rounds, two on each side
- Steel spring in each tube holds rounds securely until needed
- Stored shells instantly available for loading with the flick of a finger
- Set includes stock, forend and recoil pad



0252 Remington 11-87 12-Gauge



0250 Remington 870 12-Gauge



0254 Remington 1100 12-Gauge



0255 Mossberg 500/590 12-Gauge



0256 Winchester 1200/1300 12-Gauge



0250CAT Remington 870 12-Gauge



0250CFDE Remington 870 12-Gauge



0250CMC Remington 870 12-Gauge

SPEEDFEED





13

SPEEDFEED — TACTICAL & LE STOCKS

SPEEDFEED® IV STOCK SETS

- Comes complete with our recoil-reducing sport pad and forend



0260 Remington 870 12-Gauge



0262 Remington 11-87 12-Gauge



0264 Remington 1100 12-Gauge



0265 Mossberg 500/590 12-Gauge



0266 Winchester 1200/1300 12-Gauge



0270 Benelli Super 90 12-Gauge

SPEEDFEED® IV-S STOCK SETS

- This special model includes all the outstanding features of the SPEEDFEED® IV with a shortened, 13-inch length-of-pull
- Shortened length-of-pull is ideal for small-frame shooters, use with body armor and tactical requirements



0280 Remington 870 12-Gauge



0282 Remington 11-87 12-Gauge



0284 Remington 1100 12-Gauge



0285 Mossberg 500/590 12-Gauge



0286 Winchester 1200/1300 12-Gauge



029 Benelli Super 90 12-Gauge



PISTOL-GRIP STOCK SETS

- The SPEEDFEED® Pistol-Grip Set features a unique angle to the plane of the shotgun
- Recoil is kept to minimum, allowing shot-by-shot control
- Comes complete with forend and sling-swivel stud



0390 Remington 870 12-Gauge

0392 Winchester 1200/1300 12-Gauge



LESS LETHAL STOCK SETS

- These international orange stocks allow law enforcement to quickly and definitively assign and identify less lethal firearms



0303LL Remington 870 12-Gauge



0101LL Remington 870 12-Gauge



0302 Remington 870 12-Gauge



0303 Remington 870 12-Gauge



SPEEDFEED



CLEANING KITS

POLICE KITS

- Tailored specifically to meet the cleaning needs of firearms that are used heavily in the field
- The police handgun kits and the shotgun kit include a 1/4" diameter, precision ground stainless steel rod
- The 5.56mm, 7.62mm and .30-06 kits include a solid steel, black oxide rod
- Both rods feature a muzzle guard to prevent damage to the bore and a rotating handle that provides a precise clean by allowing the rod to tightly follow the rifling
- Each kit features a 2 oz. bottle of powerful No. 10 Copper Cutter to counter the effects of jacketed rounds
- Includes 1/2 oz. Break Free® Lubricant/Protectant – a synthetic oil specially formulated for modern firearms
- Kits also include 100% cotton patches, a doubled-ended nylon brush, a Silicone Gun and Reel Cloth and caliber specific jags, brushes and mops



- PS50** .38/.357/9mm
- PS51** .40/.41/10mm
- PS52** .44/.45 Caliber
- PS53** 5.56mm
- PS54** 7.62mm
- PS55** .30-06
- PS56** 12-Gauge



15

KLEENBORE — CLEANING KITS



CLASSIC SETS

- Features the best made cleaning components in the industry, neatly housed in a custom organizer tray and then securely packaged in a rugged, reusable polypropylene storage and carrying case
- Rods in the Handgun, Rifle and Black-powder Kits are made of a smooth, high-grade steel (for maximum strength) with a black oxide finish and rotating handles
- Each kit also includes a plastic muzzle guard to protect the crown of the barrel during the cleaning process
- The shotgun kits feature a polished aluminum, three-sectioned rod set
- All kits include a 2 oz bottle of Break Free® CLP® to Clean, Lubricate and Protect the firearm, a double-ended nylon utility gun brush, Silicone Gun and Reel Cloth and 100% cotton patches
- A Classic Kit is available for virtually every firearm you own

BK214 Universal Muzzleloading Kit

- Set up like the Classic Universal Kit, this is the perfect starter kit for all muzzleloading applications
- Kit comes with the absolute basics such as a variety of patch holders and all necessary hardware
- Brushes are sold separately

SAF-300 Saf-T-Clad® Universal Cleaning Kit

- The Universal Saf-T-Clad® Kit cleans handguns, rifles, and shotguns and is neatly packed in a storage case
- This convenient kit includes a five-section, 30" Saf-T-Clad rod w/muzzle guard, nylon gun brush, Break Free® CLP®, handgun/rifle patch holder, shotgun patch holder, accessory adapter, cotton patches, and a silicone gun and reel cloth
- Just team up the desired brushes to clean the firearm of your choice

UK213 Universal Kit

- The forerunner of the multi-use cleaning kit, the Universal Kit allows users the ability to clean an array of firearms



RIFLE KITS

- Classic Rifle Kits utilize steel rods rather than aluminum because they are more durable and less abrasive
- Engineered like the rods specified by the U.S. Government, they offer a much better thread system than the competition
- Rods are less apt to bend and break where the sections connect
- Kits are caliber specific and include the appropriate bore brush and cotton patches

- K204** .243/.25/6.5mm
- K206** .264/.270/7mm
- K209** .41/.45 Caliber
- K205** .22/.223/5.56mm
- K207** .30/7.62mm
- K208** .338/8mm

Classic Kit Contents

	Steel Rod with Swivel Handle		Aluminum Rod		Shotgun Accessory Adapter	Accessory Adapters	Nylon Bristle Gun Brush	Phosphor Bronze Bore Brush	Cotton Bore Mop	Slotted Patch Holder	Brass Cleaning Jag	BReak Free® CLP®	Cotton Cleaning Patches	Silicone Gun and Reel Cloth	Muzzle Guards
	Sections	Length"	Sections	Length"											
Universal	4	30			•	•	•			2		•	•	•	•
Rifle	4	30				•	•	•		•		•	•	•	•
Handgun	1	10				•	•	•		•		•	•	•	•
Shotgun			3	32	•			•	•	•		•	•	•	•
Muzzleloading	5	37			•	•	•			2		•	•	•	•
.17 & .204 Caliber	3	34					•	•	•		•	•	•	•	•





HANDGUN Kits

- Classic Handgun Kits include two working rod sections, both of which are threaded to accept all standard #8-32 accessories
- KleenBore™ swivel handle section will clean up to a 7" barrel, and with the included 2 3/4" rod extension, handle up to a 10" barrel handgun
- Both of the #8-32 threaded handgun rod components can be identified by a groove in the rod end

K211 .22 Caliber
PK210 .38/.357/9mm
K212 .44/.45 Caliber
K215 .32 Caliber
K218 .25 Caliber
K220 .40/.41/10mm

SMALL BORE Kits

- The .17 and .204 caliber kits feature KleenBore™ signature solid steel, three-piece rod with rotating handle 34 inches in length
- The rotating handle allows the rod to tightly follow rifling, preventing the small caliber firearms from becoming inaccurate due to fouling
- A 2 oz. bottle of Break Free® CLP® provides a quick and easy gun care that cleans, lubricates and protects
- Also included are caliber-specific phosphor bronze brushes, cotton mops and precision brass jags
- A double-ended nylon bristle brush, 100% cotton patches and a silicone gun and reel cloth finish the small bore kits

K20 .204 Caliber
K17 .17 Caliber
K1704 .17/.204 Caliber
SAF-K17 .17 Caliber



SHOTGUN Kits

- KleenBore™ rods in every shotgun kit are premium grade, tight-threading aluminum

SHO216 12-Gauge
SHO217 20-Gauge



FIELD PACK KITS

- A favorite of hunters, law enforcement, and the military, these compact, easy-to-carry kits go where you go
- Everything needed for a complete cleaning is included in the rugged nylon pouch with a belt keeper or MOLLE attachments, and hook and loop closures and compartments for rod and accessories
- In the field or on the range, these kits are compact enough to carry for fast and easy removal of impacted mud, snow or a squib load



UNIVERSAL Cleaning Kits

- Military-style four piece steel cleaning rod
- Shotgun accessory adapter
- Accessories adapter
- Double ended nylon bristle utility brush
- A slotted patch holder and a shotgun patch holder
- Universal cotton cleaning strips
- 1/2 oz. Break Free® CLP®
- Silicone Gun and Reel Cloth
- Bore brushes sold separately

- POU300B** Black
- POU300C** Camo
- POU300T** Tan
- POU300DC-A** Digital Camo Tan
- POU300DC-M** Digital Camo
- POU-300AFC** Air Force Camo

HANDGUN/RIFLE Cleaning Kits

- Military-style four piece steel cleaning rod
- Accessories adapter
- Double ended nylon bristle utility brush
- A slotted patch holder
- Universal cotton cleaning strips
- 1/2 oz. Break Free® CLP®
- Silicone Gun and Reel Cloth
- .22/.23/5.56mm, .30/7.62mm and .44/.45 bore brushes

- POU301B** Black
- POU301T** Tan
- POU301C** Camo



AR15/M16 Cleaning Kits

- Military-style four piece steel cleaning rod
- Accessories adapter
- Double ended nylon bristle utility brush
- A slotted patch holder
- Cotton cleaning patches
- 1/2 oz. Break Free® CLP®
- Silicone Gun and Reel Cloth
- Military-spec chamber and bore brushes
- 9mm bore brush POU302AFC only

- POU302B** Black
- POU302C** Camo
- POU302T** Tan
- POU302DC-A** Digital Camo Tan
- POU302DC-M** Digital Camo



SPECIALTY KITS



19

KLEENBORE — SPECIALTY KITS



AG-1 AllGun® Universal Cleaning System

- Versatile kit features an expandable soft leather-like pouch with everything needed to efficiently clean all types of firearms
- Self-contained and handy, this unique kit unrolls to display an assortment of cleaning tools and accessories
- Soft closure flap makes an excellent gun mat to protect firearms during cleaning
- AllGun® is one of the most complete and compact cleaning kits available, making it ideal for in the field or at home
- A great gift for the traveling hunter or competition shooter
- The AllGun® Universal Cleaning system also includes:
 - .22/.30/.38/.357/9mm/.45 and 12-Gauge phosphor bronze brushes
 - 12-gauge cotton bore mop
 - Universal, four-piece steel cleaning rod
 - Muzzle guard
 - Handgun/rifle adaptor, patch holder
 - Shotgun accessory adapter, patch holder
 - No. 1 and No. 3 screwdrivers
 - .68 oz. Break Free® CLP®
 - Double-ended nylon bristle utility brush
 - Silicone Gun and Reel Cloth



POCKIT Handgun Kits

- Unique design of PocKit handgun cleaning kits allow you to pack a two-section rod in a patented storage handle
- Holds a phosphor brush, mop and jag for easy, convenient storing and carrying
- The first rod section with muzzle guard, cleans 2" to 5" barrels including most semi-automatics
- Add a second section for barrels up to 8 3/8"
- PocKit cleaning sets are offered in a variety of popular handgun calibers and the rod sections accept all KleenBore™ handgun accessories (#8-32)

- POC220** .22 Caliber
- POC222** .38/.357/9mm
- POC224** .40/.41/10mm
- POC226** .44/.45 Caliber



SAF-T-CLAD® RODS

- Saf-T-Clad® products are the result of a technological breakthrough involving epoxy thermal setting resins
- Resins are carefully applied in the United States on local, high-grade, solid-steel rods, and securely bond our Saf-T-Clad® coating
- This special process provides an unbelievably smooth surface for the ultimate in rifling and bore protection
- An excellent choice for shooters who do a lot of cleaning and expect absolute precision from their equipment



SAF301 Universal Rod Set

- Compact, reusable clamshell case contains a five-section 30" rod with black nylon muzzle guard
- Handgun/rifle patch holder, shotgun patch holder and accessory adapter (.22-.45, all gauges)



SAF400 One-Piece Rifle Rod

- 33" Saf-T-Clad® rod comes with a protective muzzle guard and coated patch holder
- Non-segmented for strength and seamless cleaning
- This rod is an economical workhorse for any .22-.45 caliber rifle



SAF303 .17 Caliber Rod

- 33" one-piece rod comes with a phosphor bronze brush, cotton mop and barbed .17 caliber brass jag
- Distinctive blue coating is securely bonded to a steel rod for strength and added bore protection
- Can also be used on a .204 cal. with proper brush



SAF302 Handgun Rod

- Tailored specifically for handguns
- 6 1/2" Saf-T-Clad® rod and accompanying coated patch holder cover .22-.45 caliber pistols and revolvers with barrels up to 8"



SAF-401

Deluxe Two-Piece Rifle Rods .22-.264

- Created especially for precision shooters
- 46" rod, machined from 13/64" diameter steel
- Feature brass muzzle guards, patch holder, .22-.25 jags, black Saf-T-Clad® coating and nylon swivel handles with brass faceplates
- Use the 25" working handle section to clean shorter barrels from the muzzle end
- Add the 20" second section for longer barrels or when cleaning from the breech



CLEANING RODS

CLASSIC ONE-PIECE RODS

- A wide variety of American made non-segmented rods in steel and aluminum in an array of lengths to meet your needs
- All rods are carefully crafted to be strong, no-fray and remain straight in the barrel. Some imported rods can bow, break, or peel, damaging valuable rifling
- One-piece, U.S. made rods with rotating handles



OP105 .17 Caliber/Airgun

- 33" Steel rod with phosphor bronze bore brush, cotton mop and a brass jag

OP106 .22-.45 Handgun

- 6½" Steel rod with a slotted patch holder

OP107 .22-.45 Rifle

- 33" Steel rod with a slotted patch holder

OP108 Shotgun All Gauges

- 34" Aluminum rod with a slotted patch holder and accessory adapter

OP110 .38-.45 Caliber GI Issue

- 8" Steel rod with built in patch holder and female #8-32 threaded end

DELUXE ONE-PIECE RODS



DR100 .22-.45 Handgun

- 9" Stainless steel rod with a slotted patch holder

DR101 .22-.45 Silhouette

- 16" Stainless steel rod with a slotted patch holder

DR101A .22-.45 Silhouette

- 22" Stainless steel rod with a slotted patch holder

DR102 .22-.45 Rifle

- 33" Stainless steel rod with a slotted patch holder

DR100B .22-.45 Handgun

- 9" Brass rod with a slotted patch holder

DR102B .22-.45 Rifle

- 33" Brass rod with a slotted patch holder

DR103 Shotgun All Gauges

- 34" Stainless steel rod with a slotted patch holder and accessory adapter

DR103B Shotgun All Gauges

- 34" Brass rod with a slotted patch holder and accessory adapter

DR106 .22-.45 Benchrest

- 44" Stainless steel rod with a slotted patch holder

MULTI-SECTIONAL CLEANING RODS

- KleenBore™ rods are precision-machined in the United States from top quality stock to exacting tolerances and surface smoothness
- Won't bow, break, bend or fray, which can cause damage to precious rifling
- Durable nylon handles on the rifle and pistol models rotate smoothly allowing brushes and jags to travel efficiently down the bore
- All multi-section rods are packaged in well-made vinyl pouches for long-term storage



A171 Shotgun All Gauges

- Three-piece 32" aluminum rod with a slotted patch holder and shotgun accessory adapter

A173 Blackpowder

- Four-piece 46" aluminum rod with two slotted patch holder and shotgun accessory adapter (5/16-27 thread)

KB99 Universal Big Bore

- Four-piece 33" stainless steel rod with a slotted patch holder, shotgun patch holder and shotgun accessory adapter (5/16-27 thread)

AIR174

.177/.200 Handgun/Rifle/Airgun

- Two-piece 23" steel rod with a black nylon bore brush, cotton mop and brass pellet pusher/jag

S169 .17 Smallbore

- Three-piece 34" steel rod with a phosphor bronze bore brush, cotton mop and a jag

S170 .22-.45 Handgun/Rifle

- Four-piece 34" steel rod with a slotted patch holder and accessory adapter (#8-32 thread)

VALU-PAK ROD SETS

- This economical cleaning kit is the perfect alternative to purchase a full kit at Valu-Pak price
- All components are the same American made components as all our rods and accessories with precise specifications and a smooth, tight fit
- Caliber specific kits listed below include muzzle guards, patch holders, phosphor bronze brushes and mops
- The VP-60 does not contain these items because of its universal nature
- All items are nicely packed in a storable, reusable clam

VP12 12-Gauge Shotgun

VP20 20-Gauge Shotgun

VP60 Universal Handgun/Rifle/Shotgun

VP61 .22/.223/.225/5.56 Rifle



TOOLS & ACCESSORIES

BORE BRUSHES & MOPS

BRUSH & MOP THREAD SIZE

Type	Thread Size
Handgun/Rifle	#8-32
Shotgun/Blackpowder	5/16"-27
Small Bore .17, .204 caliber	#3-48
Military Style Brushes	#8-36

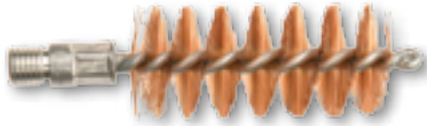
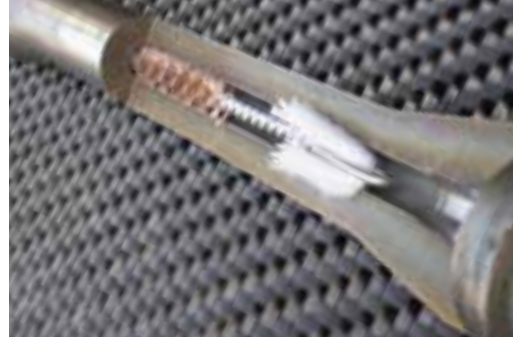

PHOSPHOR BRONZE Brushes

- These precisely designed brushes feature KleenBore™ carefully-made, thicker, straight bronze wire bristles
- Designed with rounded, smoother bristle tips rather than sharp, crimped, narrow imported brushes.
- These bronze brushes offer more safe and effective cleaning power
- Will not easily bend from force down the bore
- Guaranteed not to damage precious rifling

RIFLE

A175	.17/.200 airgun
A177	.22/.223/5.56mm
A178	.243/.25/6mm/6.5mm
A179	.270/7mm
A180	.30/7.62mm
A163	.338/8mm
A181	.35/9mm
A160	.375/.380
A164	.416
A182	.44/.45
A194	.50

HANDGUN

A188	.22
A162	.25
A189	.32
A190	.38/.357/9mm
A191	.40/.41/10mm
A192	.44/.45
A195	.475/.480
A193	.50

SHOTGUN

A183	.410
A161	28
A184	20
A185	16
A186	12
A187	10



STAINLESS STEEL Bore Brushes

- Recommended for excessive leading, wad fouling and rust removal
- Use extreme care to avoid bore damage

RIFLE

SS214	.30/7.62mm
SS222	.35/9mm

HANDGUN

SS211	.38/.357/9mm
SS215	.40/.41/10mm
SS212	.44/.45

SHOTGUN

SS218	12
SS217	10

STAINLESS STEEL Cylinder Brushes



- Stainless Steel Cylinder Brushes are sized properly to clean the cylinder chambers of a revolver
- Help remove carbon build-up within the chambers for a smoother loading and extraction

C-201	.38/.357
C-203	.44/.45



BENCHREST Brushes

- These brushes have all the benefit of our standard phosphor bronze, however offer a brass core and threaded couplings for added durability in the field

BR167	.22/.223/5.56mm
BR168	.243/.25/6mm/6.5mm
BR169	.30/7.62mm





BLACK NYLON Bore Brushes

- Rugged, stiff, black nylon bore brushes are recommended by many major firearms manufacturers for bore cleaning
- Compare the dense, heavy-duty, thick nylon bristles to other wire brushes and see why they are so effective for even the toughest cleaning jobs

RIFLE	
A175N	.17/.200 Airgun
A177N	.22/.223/5.56mm
A178N	.243/.25/6mm/6.5mm
A179N	.270/7mm
A180N	.30/7.62mm

HANDGUN	
A188N	.22
A190N	.38/.357/9mm
A191N	.41/.41/10mm
A192N	.44/.45

SHOTGUN	
A184N	20
A186N	12
BLACKPOWDER	
BP193N	.44/.45
BP194N	.50
BP195N	.54/.55



BLACKPOWDER Brushes

- The bristles extend completely to the tip to clean the entire chamber

BP191	.32
BP193	.44/.45
BP194	.50
BP195	.54/.55

BP199	.56
BP196	.58
BP197	.69



TWISTER Coiled Brushes

- Chosen for their unique, brass spiral design and ability to make quick work of stubborn plastic, powder and fouling from shotgun bores
- For the ultimate in a safe wire brush

RIFLE	
T308	.22
T310	.30/7.62mm
T311	.32
T312	.35
T313	.38/.357/9mm
T314	.40/.41/10mm
T315	.44/.45 Caliber

SHOTGUN	
T317	410-Gauge
T317A	10-Gauge
T318	12-Gauge
T321	20-Gauge
T322	16-Gauge



PATCH HOLDER Brushes

- The combination patch holder and brush will work together to loosen and trap fouling at the same time

RIFLE	
A177PH	.22/.223/5.56mm
A180PH	.30/7.62mm
A194PH	.50

HANDGUN	
A188PH	.22
A162PH	.25/.257
A189PH	.32
A190PH	.38/.357/9mm

A191PH	.40/.41/10mm
A192PH	.44/.45
A195PH	.475/.480



MILITARY STYLE Brushes

- All KleenBore™ military style brushes are designed specifically for M-16, AR-15, AK-47 and similar rifles
- The brushes are available in .22/.223/5.56" and .30/7.62mm
- The chamber brush is configured with two diameters; the first stage of phosphor bronze cleans the chamber area, while the second stage of stainless steel cleans the bolt-lock area

M16B	.223/5.56mm (bore) (#8-36)
M16C	.223/5.56mm (chamber) (#8-36)
AKB	.30/7.62mm (bore) (#8-36)

AKC	.30/7.62mm (Chamber) (#8-36)
SKS	.30/7.62mm (Chamber) (#8-36)

- Feature core wire looped through a brass coupling that is threaded at #8-36
- Bore brushes are made of phosphor bronze with a brass wire core for a longer life for rigorous cleaning
- Please note the #8-36 thread is not commercially standard, but will fit most KleenBore™ multi-section rods



COTTON Bore Mops

- 100% cotton provides the absolute best absorbency over any synthetic-fiber mop
- Thickest, best cleaning and lubrication mops on the market

SMALLBORE	
MOP220	.17/.204 (#3-48 thread)

HANDGUN & RIFLE	
MOP221	.22-.270/6mm-7mm
MOP222	.30-.38/.357/9mm
MOP223	.40-.45/10mm

AIRGUN	
MOP22	.17/.200/.22
SHOTGUN & BLACKPOWDER	
MOP224	.410/.44-.50
MOP225	28/20/.54-.58
MOP226	16/12/10/.69-.75



UTILITY BRUSHES



UT221 Nylon Bristle Gun Brush

- This military spec brush is great for cleaning any type of firearm, especially where a gentle touch is required
- Nylon bristles are rugged and solvent-resistant



UT222 Stainless Steel Gun Brush

- Rugged stainless steel bristles make short work of caked-on powder residue and burn marks on revolver top straps, frames and cylinders



UT223 Phosphor Bronze Gun Brush

- A superb, general purpose, gentle-on-the-finish brush for cleaning powder and lubrication residue from handguns, rifles and shotguns

CLEANING JAGS

- A metal jag, draped with a proper sized patch, completely covers the entire bore for efficient, thorough cleaning
- For ease of use, KleenBore™ unique design incorporates a special barbed point at the tip of the jag to secure the cleaning patch and prevent solvent soaked patches from falling off

JAG226 .177/.200 Airgun
JAG228 .270-.32 Caliber
JAG231 .44/.45 Caliber
JAG17 .17-.204 Caliber
JAG229 .38/.357/9mm

JAG233 20-16-Gauge
JAG227 .22-.25 Caliber
JAG230 .40/.41/.410/10mm
JAG234 12-Gauge
JAG250 .50 Caliber



JAG-X2 Universal Jag & Patch Strip Dispenser

- The JAG-X2 offers a convenient way to clean everything from a .22-.45 caliber firearm
- Simply follow the scale on the back of the dispenser and cut the desired length of patch for the caliber to be cleaned
- Wrap the patch around the barbs and clean away
- Contains approximately 84" of material



MULTI-CHOKE Shotgun Cleaning Jag

- Multi-choke nylon jags offer an efficient way of cleaning a bore and choke
- Petal design compresses when bore cleaning, the patch is continually putting equal pressure on the bore for a better cleaning job
- Allows the dirty patch to compress and pass thru a full choke and out the muzzle instead of back into the chamber
- The barbed tip secures the patch while cleaning
- The #5/16-27 thread will fit all KleenBore™ shotgun rods

JAG12N 12-Gauge
JAG20N 20-Gauge



MUZZLE GUARDS

- Use of a muzzle guard can prevent the damage to the sensitive barrel crown when cleaning from the muzzle end
- A muzzle guard keeps the cleaning rod centered
- Works equally as well when cleaning bolt-action rifles from the muzzle or breech



ACC14 Brass for .203 dia. handgun/rifle rods
ACC14SAF Brass for Saf-T-Clad® rods (Except SAF-402)
ACC18 Brass for deluxe shotgun/blackpowder rods



ACC24
Plastic for .203 dia.
handgun/rifle rods

CLEANING ROD EXTENDERS



ACC15 6 3/4" Steel Center Section



ACC27 10" Stainless Steel Extension
• Fits Deluxe Rod series



ACC15SAF 6 3/4" Saf-T-Clad®
Center Section



ACC28 2" Steel Handgun Extension



DR105B 10" DR104B Extension





PATCH HOLDERS & ADAPTERS

- These carefully crafted accessories guarantee perfect, smooth mating to rods
- Prevents peeling or mismatched segments that can seriously damage bores



ACC9 Handgun/Rifle Conversion Adapter

- Permits use of KleenBore™ accessories on Outers rods



ACC10 Steel Handgun/Rifle Slotted Patch Holder .22-.45



ACC10SAF Saf-T-Clad® Handgun/Rifle Slotted Patch Holder .22-.45



ACC11 Brass Handgun/Rifle Slotted Patch Holder .22-.45



ACC12 Nickel-Plated Handgun/Rifle Slotted Patch Holder .22-.45



ACC13 Handgun/Rifle Accessory Adapter
• #8-32 female thread #8-36 male thread



ACC13SAF Saf-T-Clad® Accessory Adapter



ACC16 Nylon Shotgun Slotted Patch Holder All Gauge



ACC17 Aluminum Accessory Adapter
• Accepts all KleenBore™ shotgun accessories (#5/16-27)



ACC19 Blackpowder Adapter
• Converts #10-32 rod end for #5/16-27 accessories

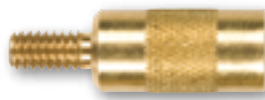

ACC20 Blackpowder Adapter
• Converts #10-32 rod end for #8-32 accessories



ACC23 Brass Accessory Adapter
• Accepts all KleenBore™ shotgun accessories (#5/16-27)



ACC-21 Blackpowder Ball Pusher
• #10-32 thread .45 caliber and larger



ACC29 Brass Conversion Adapter
• #3-48(M) to #5-40(F) Conversion Adapter



ACC30 Brass Conversion Adapter
• #5-4(M) to #3-48(F) Conversion Adapter



MAGAZINE BRUSHES & MOP

- Important item for competitive shooters, law enforcement and the military
- The patented MagBrush removes gummy residue, dust, dirt and unburned powder from inside the magazine
- Provides quicker, easier magazine release and increased cartridge-feed reliability
- Companion to the MagBrush series, the MagSwab can be used with a solvent to mop clean the inside of magazines
- Have an additional MagSwab on hand to solely apply a light coat of lubricant to protect to protect both areas after cleaning



MAG208 MagSwab 9mm Staggered/.38/10mm/.40/.45

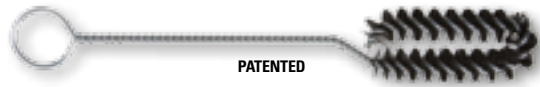

- MAG200** MagBrush .22/.25/.380/9mm Straight Stacked
- MAG202** MagBrush 9mm/10mm/.40/.45 Staggered
- MAG204** MagBrush .38/.40/10mm/.45 Straight Stacked
- MAG206** MagBrush AR-15/M-16/AK-47

SPECIALTY TOOLS



SHOTGUN Snap Caps

- Firing on an empty chamber can result in damage to a firing pin
- Using Snap Caps in empty chambers allows for the safe release of the firing pin, or "dry-fire"
- The caps also serve to relieve pressure on the firing pin spring when camber is closed and the trigger is pulled
- Made from solid aluminum and brass spring loaded primer to absorb the force of the firing pin and prevent damage, the caps are color coded and stamped with the appropriate gauge

- CAP12** 12-Gauge
- CAP20** 20-Gauge



ACU1 Accu-Wedge

- Buffers AR-15/M-16 cycling system to reduce wear and provides a more solid feel by eliminating play in the receiver
- Easy to install, requires no firearms modifications

BL304 Bore Inspector®

- Fiber optics light the bores of handguns, rifles and shotguns to make checking for leading, fouling, and rust fast and easy
- Ideal for regular firearms maintenance or for examining used guns prior to purchase
- Two AAA replaceable batteries supplied

CF-9 .45/9mm Chamber Flag

- On the range and when transporting or storing semi-automatic handguns, a chamber flag immediately indicates that the gun is clear and no round can be chambered

CF-22 .22 Caliber Chamber Flag





CLAYMATE® Shotgun Cleaning Tool

- The ClayMate is a compact two-section shotgun cleaning tool
- The soft fibers of ClayMate effectively pick up unburned powder, which is lifted by a screw-on phosphor bronze brush—providing unbelievably quick and effective cleaning
- Also included is a screw on bore mop for applying a light coating of a favorite KleenBore™ solvent or lubricant
- Total assembled length is 36", breakdown length is 19" for easy storage in a gun case or range bag
- The ClayMate can be easily washed and reused for another day of busting clays



CM270 12/16-Gauge ClayMate Shotgun Cleaning Tool
CM272 20-Gauge ClayMate Shotgun Cleaning Tool

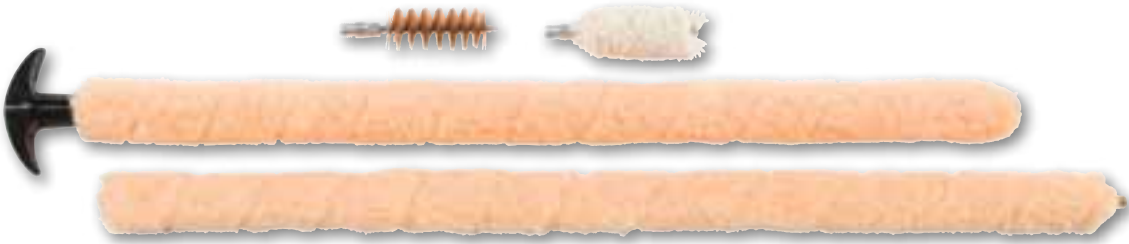

VCI GUNNYSOCKS

- Corrosion in storage can be a real problem for firearms collectors and enthusiasts
- KleenBore™ has applied the same Vapor Corrosion Inhibitor technology in the Inhibitor bags to provide a convenient alternative
- VCI technology penetrates into the smallest cracks and crevices of firearms that oils can not reach, offering unbelievable long-term protection of the Gunnysocks of old
- VCI Gunnysock better fits scoped firearms and provides a cushioning layer of fabric around your valuable firearms
- These socks are not only perfect for storage, but also short-term travel and even are considered a travel case because of the string around the end of the sock in many ranges nationwide

GSVCI161 Rifle/Shotgun (including scope)

CHAMBERMATE Shotgun Cleaning Tool

- The ChamberMate is a rugged tool with a strong aluminum rod and sure grip handle
- A heavy-duty phosphor bronze brush with tapered nose is made to fit difficult-to-clean areas and is ideal for quickly cleaning muzzle ports from the inside out
- The brush is great for cleaning powder fouling and plastic from chambers and choke area

SC225 12-Gauge
SC226 20-Gauge



THE PROTECTOR Gun Cleaning Mats

- KleenBore™ professional gun cleaning mats are ideal for firearms cleaning, maintenance and protection at the range or in the field
- This soft, sealed surface protects firearms during cleaning and maintenance, while absorbing spills because of its deep wicking properties
- The Protector has a non-skid, non-leaking back (to most solvents tested)
- Easily cleaned by simply washing with soap and water

GM24 Handgun 18"x 24"
GM48 Rifle/Shotgun 18"x 48"



30

KLEENBORE — TOOLS & ACCESSORIES

800 347 1200

safariland.com/firearmsaccessories

GUNSMITHING TOOLS

T0045 Pro Gunsmith Screwdriver Set

- 26 hardened steel bits: Phillips, Slotted, Hex, Torx, and Posi-Drive
- Three long bits for recoil pad and see-thru mount installation
- A full-featured screwdriver
- One 1/4" socket drive adapter
- All housed in a sturdy molded case with individual compartments for each item



T1001 Cross Hair Alignment Tool

- Will square up your scope or front sight in seconds
- Accurately sets scope vertical reticle position and determines front sight ramp vertical
- Eliminates removal of action and barrel from gunstock
- Fits into the receivers of most bolt action centerfire rifles
- Made of optically clear plastic that will not mar the gun's finish



T0114 Sling Swivel Installation Kit

- Use with an 1/4" electric hand drill or in a drill press
- Includes a 5/32" drill bit, 7/32" safety counterbore drill bit and a #10 drill bit

T1005 Bubble Level 11mm Dovetail

- Insures bore alignment and reticle alignment at a glance
- White scribed line on housing for quick reference



T1006 Bubble Level Weaver



T1100 Front Sight Pusher

- Adjusts dovetail sights without hammering or damage
- Two hardened posts opposite a pusher ram extend or retract by turning a screw



T1864 SKS/AK Front Sight Elevation kit

- Sight Pusher tool clamps to the front sight post
- Adjusts sight in either direction without repositioning
- Sight Elevation Tool T-Handle wrench fits over the gun's front sight post
- Screws in or out for elevation adjustment
- T1863 SKS/AK Sight Elevation tool



31

KLEENBORE — TOOLS & ACCESSORIES

safariland.com/firearmsaccessories 800 347 1200



RIL219 Inhibitor Long Gun Storage Bag 14"x54"

- These sturdy, 6 mil. VCI Inhibitor storage bags provide long-term corrosion protection for all your valuable firearms and other metal possessions
- Incorporating the technology of Vapor Corrosion Inhibitors to blanket your firearms with an invisible shield from corrosive atmospheres for up to three years, the combination of VCI protection and moisture absorbing desiccant action protects against normal humidity and oxidizing atmospheres as well as corrosive marine and tropical environments
- This technology provides full corrosion protections, without the need to clean or degrease prior to use
- Available for handguns and long guns



TARGETS



B27B Police Silhouette

- 24" x 45"
- Paper



K5 Bad Guy

- 23" x 35"
- Paper



COTTON PATCHES & CLOTHS

- Premium quality 100% cotton flannel provides maximum absorbency and bore protection
- These patches are precision cut to ensure the proper fit and maximum cleaning performance when used in conjunction with our cleaning jags
- These same quality 100% cotton patches are available bulk-packaged for high volume users such as competition shooters, gun clubs, law enforcement agencies, gunsmiths, and others



P200	7/8"	Small Bore	100 Count
P201	1 1/4"	.22-.270	100 Count
P202	1 3/4"	.28-.35 Caliber	75 Count
P203	2 1/4"	.38-.45/.410-20-Gauge	50 Count
P204	3"	12-16-Gauge	25 Count
P206	4"	Big Bore Shotgun	25 Count

CP16B	1 1/4"	.22-.270 Caliber	500 Count
CP17B	1 3/4"	.28-.35 Caliber	500 Count
CP13B	2 1/4"	.38-.45/.410-20-Gauge	250 Count
CP18B	2 1/4"	.38-.45/.410-20-Gauge	500 Count
CP14B	3"	12-16-Gauge	250 Count
CP19B	3"	12-16-Gauge	500 Count



LP-199 Lead Away® Patches

- Lead Away Patches wipe away stubborn carbon and lead build-up
- (25) 1 1/4" square patches in a resalable clamshell package with hanger hole



GC-221 Lead Away®

- This chemically treated cloth is ideal for removing tough lead and carbon build-up. Excellent for removing burn rings on cylinders and on stainless steel
- Excessive rubbing may remove bluing



GC-220 Silicone Gun & Reel Cloth

- Restore and protect the luster of your firearms with our top-quality silicone impregnated cotton flannel
- This 100 square inch cloth returns a brilliant sheen to your gun's surface, while removing handling marks and providing a layer of rust protection



CLEANERS & SOLVENTS

GB2 Black Magic™ Bluing Solution 2 oz. (59 ml)

- This premier, high performance cold bluing solution, previously available only to gunsmiths, produces a deep, penetrating action to restore worn or scratched gun metal to like-new finish
- Black Magic is the choice of major firearms manufacturers for touching up guns before they leave the factory
- Packaged in a container with a child-resistant cap and expert, easy-to-follow instructions



G05A Gunk Out™ Cleaner Degreaser 15 oz. (55 g) Aerosol

- Gunk-Out quickly blasts away caked-on oil contaminated with dirt, dust and powder residues
- The chemical is also great for flushing out loosened fouling and for degreasing prior to bluing



NO. 10 GUN CLEANING SOLVENT

- Tried and true, No. 10 is a fast, efficient solvent that quickly penetrates and lifts lead, powder residue, and metal fouling for quick, easy cleaning



S10S
2oz. (59 ml)
With Pump Spray



S10
2oz. (59 ml)
With Dropper Tip



S10A
3 1/3 oz. (43 ml) Wide
Mouth Glass Jar



S10B
1-Pint (470 ml)
Barex Container



S10C
1-Quart (946 ml)
Barex Container

NO. 10 COPPER CUTTER

- Reformulated for even better removal of copper and other fouling, this premium, high-strength solvent rapidly turns blue as it aggressively cuts through copper
- No blue, no copper
- Also ideal for removing plastic fouling



C10
2oz. (59 ml)
With Dropper Tip



C10A
3 1/3 oz. (43 ml) Wide
Mouth Glass Jar



C10B
1-Pint (470 ml)
Barex Container



C10C
1-Quart (946 ml)
Barex Container





GC-16 12 oz. (340 g) Powder Blast™

- Powder Blast™ keeps all guns clean and dry by blasting away firing residues
- Use it on trigger groups and mechanisms to quickly and easily remove contaminants, without leaving a white residue or unpleasant odor
- Eliminates powder residue, plastic streaking, grease and oil build-up
- No disassembly required – the extender tube provides easy access to hard-to-reach areas
- Will not hydrolyze to form hydrochloric acid, unlike products containing 1,1,1 Trichloroethane
- After using Powder Blast™, protect your gun with Break Free® CLP®, or Collector®

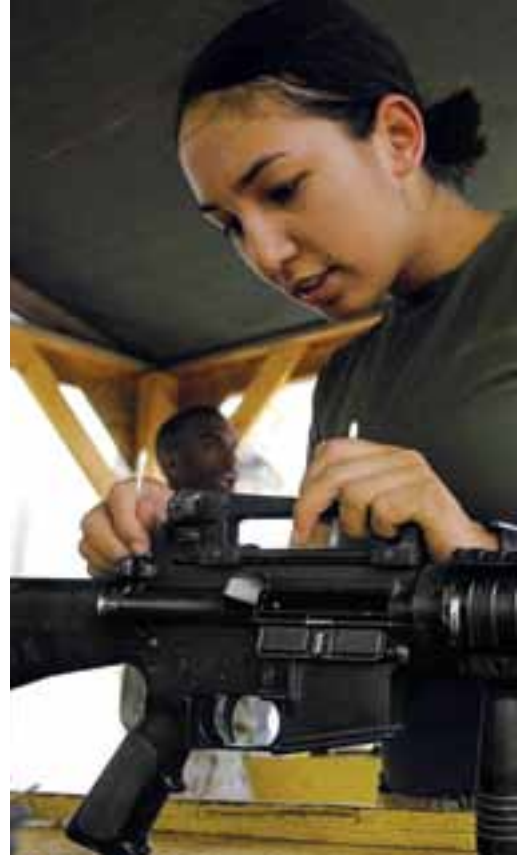

BCF-3 3.06 oz. (88 ml) Bore Cleaning Foam

- Gently cleans using a chemical reaction to remove copper and brass compounds with no mechanical friction
- Quickly removes residue in 15 minutes
- Protects with a film that slows down renewed accumulation of similar residues
- Foam application runs less than other cleaning agents, such as ammonia-based products
- Efficiently removes normal combustion waste, eliminating the need for a second cleaner
- Non-toxic, odorless, PH value of 12
- Usable in temperatures between minus 30° and 50° Celsius



CAC-4 4 oz. (120 ml) Carbon Cutter®

- Carbon Cutter® was specially formulated to cut carbon buildup from your firearm
- Carbon Cutter® liquefies the carbon from any weapon barrel. Ideal for removing carbon from black powder rifles
- Removes black powder
- No ammonia
- PH neutral



BFI-PASTE 2 oz. (56 g) Bore Paste

- Break Free® Bore Paste restores accuracy by removing hardened powder residue, copper and moly fouling
- Paste won't eat away at your bore
- Cleans quickly and better than ordinary solvents and cleaners
- A must-have for professional shooters
- After cleaning, always coat with Break Free® CLP® or Collector® to prevent rust and corrosion



LUBRICANTS & PROTECTANTS

CLEANS, LUBRICATES, PRESERVATIVE (CLP®)

- Originally developed for the U.S. Military and proven in the world's most extreme conditions
- Break Free® CLP® is the unquestioned gold standard formula for cleaning, lubricating and protecting firearms
- More than a superior lubricant, CLP actually cleans firing residue and firing residue, oil, grime and grease from the bore, moving parts and exterior of firearms while simultaneously reducing friction and protecting from corrosion

WHY BREAK FREE® CLP?

- It has been proven to perform in temperatures ranging from -65°F to +475°F and after saltwater immersion
- It is manufactured from the highest-quality polymerized synthetic oils plus special friction-reducing, anti-wear additives
- It reduces metal-to-metal wear by layering surface areas with an advanced boundary film
- It does not degrade under high temperatures and extreme pressure. Other brands may contain wax-based materials that will degrade and solidify into a gummy residue
- It displaces and loosens residue and contaminants from bearing areas
- It protects metals with special rust inhibitors





CLP-12
12 oz. (340 g) Aerosol



CLP-2
4 oz. (113 g) Aerosol



CLP-5
1-Pint (500 ml) With
Trigger Sprayer



CLP-8
1-Quart (1 l) With
Trigger Sprayer



CLP-4
4 oz. (120 ml)
Squeeze Bottle



CLP-20
2 oz. (59 ml) Bottle
With Dropper Tip



CLP-16
0.68 oz. (19 ml)
Squeeze Bottle



CLP-7
1 U.S. Gallon (3.8 l)



DP-7 Counter Merchandiser Display

Includes:

- Complimentary display tray
- 1 case of 12 aerosol cans of 12 oz. (340 g) CLP®
- 1 carton of 10 aerosol cans of 4 oz. (113 g) CLP
- 1 carton of 10 bottles of 4 oz. (120 ml) CLP
- 1 carton of 20 bottles of .68 Oz. (19 ml) CLP
- 1 carton of 10 CLP Precision Shooter® units



CLP-PS Precision Shooter®

- Needle-style applicator that delivers 0.2 ounces (7.5 ml) of CLP®
- Pinpoint accuracy to clean, lubricate, and prevent rust in hard to reach areas



BFI-WW Multi-Surface Wipes

- Break Free® Multi-Surface Wipes are soft, absorbent, nonwoven cloth wipes pre saturated with Break Free® CLP®. Eliminates the need for messy oils, cleaners and cut cloths
- Cleans and maintains small arms and rifles for use in all weather conditions
- Ideal for fishing equipment, knives and other outdoor gear
- Includes twenty 6¾" x 3" wipes



COLLECTOR

CO-4 4 oz. (120 ml) Collector®

- Developed to protect firearms for up to five years in storage, Collector® exceeds stringent military specifications
- Recommended for the occasional hunter or sports shooter as well as knife and sword collectors
- Ideal for seasonal sports equipment before placing in storage
- In one test, Collector protected steel panels from rust and corrosion for over 1200 hours in 100% humidity
- Does not degrade to waxy residue under heat or pressure
- Resists damage from fingerprint residue and minimizes the need for frequent wipe down
- Perfect for gun collectors, armories and museums



DP-2 Collector® Kit

- The Break Free® Collector® Kit includes everything needed to protect and maintain your most prized firearms for display or storage
- 4 oz. (120 ml) CLP: Cleans, lubricates and preserves using the highest quality synthetic oils and special friction reducing, anti wear additives and rust inhibitors
- 4 oz. (120 ml) Collector: Developed to protect firearm for up to five years in storage
- Will not degrade under heat or pressure, resists damage due to fingerprint residue



INDUSTRIAL



PROTECTANT CLEANER LUBRICANT (PCL®)

- A superior mineral oil based industrial maintenance lubricant
- Delivers up to four times greater performance in wear tests than other brands
- Contains synthetic base stocks and rust preventives that will not break down in extreme conditions
- Advanced boundary film provides a long-lasting protective coating to shield against rust and corrosion
- Unique migration activity actually penetrates metal surfaces forcing corrosion to flow away as physical movement occurs under bearing pressure
- Penetrates through water, forming a barrier on metal surfaces that isolates moisture, forcing it to run off or evaporate



PCL-A12
12 oz. (340 g) Aerosol



PCL-L128
1 U.S. Gallon (3.8 l)



PCL-L16
16 oz. (475 ml) With
Trigger Sprayer

LUBRICANT PRESERVATIVE

- Originally developed for fully automatic cannons used by the U.S. military. Break Free® has taken this technology designed to keep weapons working under sustained fire and brought it to the consumer market
- Contains specially formulated polymerized synthetic oils for improved boundary film strength, plus multiple ingredients to reduce friction, stop build-up of foreign particles and inhibit rust and corrosion
- Safe for all gunmetal and gunmetal finishes from blued steel to titanium as well as polymer composite firearms. Also prevents galling on stainless steel
- Non-solvent formula minimizes drain off when firearm is holstered



LP-4
4 fl.oz. (120 ml)
Lubricant Preservative

LP-5
1-Pint (475 ml)
Lubricant Preservative



WE ARE SAFARILAND:

**BODY ARMOR | DUTY GEAR | LESS LETHAL | HARD ARMOR | PROTECTIVE GEAR
ARMOR SYSTEMS | FIREARMS ACCESSORIES | FORENSICS**

www.safariland.com



Together, We Save Lives.™

**13386 INTERNATIONAL PARKWAY · JACKSONVILLE, FL 32218
800.733.3832 · OUTSIDE OF THE USA, CALL 904.741.5400 · FAX (909) 923-7400**

safariland.com/firearmsaccessories