

# YOKOMO



Yokomo is a manufacturer of competition RC products that have been used to win numerous national championships in Japan, Europe, and the United States, as well as 10 prestigious World Championship titles. Supported by legions of RC car fans around the world, Yokomo will continually strive to develop innovative, high-quality, performance RC products.



# YOKOMO

## CHAMPIONSHIP TITLES

### IFMAR

- 1/10 EP Off-Road World Champion (x6)
- 1/10 EP Touring Car World Champion (x1)
- 1/10 EP On-Road World Champion (x2)
- 1/12 EP On-Road World Champion (x1)

### JMRCA

- 1/10 EP Touring Car All-Japan Champion (x9)
- 1/10 EP Off-Road All-Japan Champion (x15)
- 1/10 EP On-Road All-Japan Champion (x8)

### ROAR

- 1/10 EP Touring Car National Champion (x4)
- 1/10 GP Touring National Champion (x2)

### EFRA

- 1/10 EP Off-Road European Champion (x1)



Yokomo is a proud supporter of the D1 GRAND PRIX professional drift series.



ROUND 4 AUTOPOLIS EVENT WINNER HKS HIPER SILVIA S15

## INDEX

4	ELECTRIC RACING CHASSIS (MR-4TC SD SERIES / MR-4BC / MR-4TC MINI / YRX-12WE)
6	<b>NEW</b> DRIFT PACKAGE SERIES
8	GT-4 SERIES (GT-4RTR / GT-4RTR II / GT-4W2L)
9	KIT LISTING
10	DRIFT BODIES & ACCESSORIES
11	BODIES
12	TOURING CAR TIRES
13	TOURING CAR WHEELS
14	TOURING CAR TIRE INSERTS TOURING CAR TIRE ACCESSORIES
15	TOURING CAR FOAM TIRES
16	BATTERIES
18	CHARGERS & DISCHARGERS
20	MOTORS
21	MOTOR TUNING DEVICES (MOTOR TUNER / TESLA METER)
22	RAYSPEED PRODUCTS
23	UPGRADE PARTS FOR ASSOCIATED CARS
24	TOOLS
25	SETTING TOOLS / STORAGE CASES
26	HARDWARE (SCREWS / SET SCREWS / NUTS / SPACER SHIMS)
27	HARDWARE (TURNBUCKLES / OTHER)
28	CHEMICALS / SHOCK OILS
29	PINION GEARS / SPUR GEARS
30	BALL BEARINGS
31	DIFF BALLS / THRUST BALLS / DECALS
32	MR-4TC SD PARTS LIST
34	MR-4TC SD CGM EXPLODED VIEW DIAGRAM
36	DRIFT PACKAGE PARTS LIST
38	DRIFT PACKAGE EXPLODED VIEW DIAGRAM
40	MR-4BC PARTS LIST
42	GT-4 PARTS LIST
44	GT-4 RTR II EXPLODED VIEW DIAGRAM
46	ABOUT YOKOMO / ADDITIONAL INFORMATION

2003 & 2004 JMRCA ALL-JAPAN NATIONAL CHAMPIONS

1/10 TOURING CAR EXPERT MODIFIED CLASS

1/10 TOURING CAR SPORTSMAN STOCK CLASS

# BACK-TO-BACK CHAMPIONS !!!



# SD

Taking touring car technology to the next level.  
Introducing the MR-4TC SD series.

- front and rear ball differentials
- low friction aluminum pro shocks with hard-coated threaded shock bodies and bladder type shock caps
- low friction universal driveshaft (steel dog bones)
- adjustable rear suspension mounts (1, 2, 3 deg toe-in mounts)
- front and rear anti-roll bars (φ 1.2mm)
- Lunsford titanium turnbuckle (8 pieces)
- ball bearings (23 pieces)
- super precision wheels and more

**JMRCA NATIONAL CHAMPION !!**  
**MR-4TC SD**  
**SSG SPECIAL**

Silver Surface Graphite  
Features optimal chassis rigidity for balanced handling. Suited for all surfaces.

**JMRCA NATIONAL CHAMPION !!**  
**MR-4TC SD**  
**BLACK SPECIAL**

Black Carbon Graphite  
The stiffer black graphite provides added rigidity. Suited for smooth surfaced tracks.

**MR-4TC SD**  
**CGM SPECIAL**

Molded Carbon Graphite  
Based on the MR-4TC SD that won both Expert and Sportsman classes at the JMRCA Japanese National Championships, the new graphite molded chassis features a balanced, low CG design, mated to a super efficient shaft drivetrain.



2003 & 2004  
JMRCA NATIONAL CHAMPION  
EXPERT MODIFIED CLASS  
**Masami Hirosaka**



2004  
JMRCA NATIONAL CHAMPION  
SPORTSMAN STOCK CLASS  
**Naoto Matsukura**



2003  
JMRCA NATIONAL CHAMPION  
SPORTSMAN STOCK CLASS  
**Shohei Maruyama**

PART NO.	DESCRIPTION	PRICE
MRTC-SD1	Yokomo MR-4TC SD SSG SPECIAL Chassis Kit	\$528.00
MRTC-SD3	Yokomo MR-4TC SD BLACK SPECIAL Chassis Kit	\$528.00
MRTC-SD7	Yokomo MR-4TC SD CGM SPECIAL Chassis Kit	\$478.00

Additional items required: 2 channel radio system (transmitter, receiver, speed controller, servo), battery (6 cell), charger, motor, touring car body (190mm width), polycarbonate paint, tires, tire glue.

## YOKOMO KITS



**JMRCA NATIONAL CHAMPION**  
**Hiroshi Suzuki**

Top 4 finishers used the MR-4BC !!  
2nd Yuichi Ajishi 3rd Shinnosuke Adachi  
4th Akira Suzuki



**EFRA EUROPEAN CHAMPION !!**

Team Yokomo's Neil Cragg drove his Yokomo MR-4BC to victory at the EFRA European championships held in Vienna, Austria (8/5-10, 2003), beating out the best off-road drivers in Europe. Congratulations !!!



Victorious in 2002,  
and again at the 2003 JMRCA Japan Nationals !!

Introducing the MR-4BC, designed to continue Yokomo's world championship-winning legacy in 4WD off-road racing. The MR-4BC SPECIAL 2003 is fully equipped, featuring titanium turnbuckles, high-strength lightweight graphite parts, blue anodized aluminum parts, and much more. A race-proven 2-belt 4WD system allows the MR-4BC to handle almost any type of surface. This championship contender comes equipped to deliver the type of performance demanded by off-road loyalists. An affordably priced entry-level standard kit is also available.

PRODUCT ID	PRODUCT DESCRIPTION	PRICE
MRBC-1S	Yokomo MR-4BC SPECIAL 2003 Kit	\$499.00
MRBC-1	Yokomo MR-4BC Standard Kit	\$280.00

Additional items required: 2 channel radio system (transmitter, receiver, speed controller, servo), battery (6 cell), charger, motor, polycarbonate paint, tire glue.

A real racer on a smaller scale.

# MR-4TC MINI

The concept for the MR4TC Mini was simple. Create a 4WD touring car class that is cost effective, competitive and a ton of fun. Yokomo's Masami Hirosaka took his twin passions for 1/12 scale and touring cars and put them together. Our new MR4TC Mini is a real racer on a smaller scale with a 3mm race-weave, carbon chassis, four wheel drive and full independent suspension. Front and rear ball differentials and universals, efficient 2-belt drive and coil-over oil shocks are part of the deal. We finished the Mini off with a four cell design, standard sized 24mm Aero Dish rims and tires and a 1/12 mini Stratus polycarbonate body. Hang on for some high-powered excitement indoors or out....the Yokomo Mini is here!

- 2-belt 4WD drivetrain
- double wishbone suspension
- ball differentials
- woven carbon graphite chassis
- oil-filled shocks
- universal driveshafts
- aluminum motor mount
- foam bumper
- ball bearings
- spur gear 78T
- pinion gear 22T
- Stratus Mini body
- aero dish wheels and slick tires



**2002 IFMAR WORLD CHAMPION**

# YRX-12WE

The definitive 1:12 scale race car, our YRX-12WE is designed around a SSG chassis with adjustable battery positioning, adjustable double wishbone front suspension and a symmetrical T-bar with both coil over oil shock and friction dampening. The SSG rear chassis brace also allows for dual side dampers. Designed for world class performance on indoor carpet tracks, the YRX-12WE kit also includes wheels and foam donuts and is topped off with a custom MS-1 clear body that is so low and swoopy we had to mold in a bump to clear the damper post screw. For indoor and outdoor racing action and 4-cell performance the YRX-12WE is the one to beat.

- SSG carbon fiber main chassis
- Yokomo Stealth 3 ball diff
- VCS oil-filled shock
- titanium turnbuckles
- ball bearings
- titanium king pins
- anodized aluminum motor mount
- MS-1 lightweight body

PART NO.	DESCRIPTION	PRICE
YRX-12WE	Yokomo YRX-12WE Kit	\$365.00

Additional items required: 2 channel radio system (transmitter, receiver, speed controller, servo), battery (4 cell), charger, motor, polycarbonate paint.



PART NO.	DESCRIPTION	PRICE
MRTC-MD	Yokomo MR-4TC MINI Kit	\$345.00

Additional items required: 2 channel radio system (transmitter, receiver, speed controller, servo), battery (4 cell), charger, motor, polycarbonate paint, tire glue.



# DRIFT PACKAGE

HIGH PERFORMANCE R/C DRIFTING

NEW DRIFT PACKAGE SERIES

From the land that invented drifting comes the first 1:10 RC kit to capture the style, passion and excitement of the hottest new motorsport rage. Our new Yokomo Drift Package series captures the look and performance of full-size drift racers in perfect detail. With aggressive body cladding plus extras like aero mirrors, windshield wipers, wings, exhaust pipes, working lights and more. Look under the hood and you'll find the newest CM version of our race-proven MR-4TC SD chassis. Light and yet very strong, the molded CM chassis is easy to build and boasts shaft-driven full time 4WD, fully adjustable double wishbone suspension, LSD ball differentials and adjustable coil-over shocks. Last, but not least, are a set of unique Super Drift tires with special drift rings to produce mind boggling drift action. What's more, you can convert the CM to competition specs by simply mounting racing wheels and tires. Get in on all the drifting action with the world leader in RC quality, performance, and innovation.



NISSAN  
**180SX**



TOYOTA  
SPRINTER  
TRUENO **AE86**



NISSAN  
*Silvia* **S15**



MAZDA  
SAVANNA  
RX-7 **FC3S**

## MR-4TC SD CM Chassis Features

- super efficient shaft drive full time 4WD system (with sealed transmission cases)
- high strength molded composite chassis
- fully adjustable double wishbone suspension
- adjustable alignment via turnbuckle tie rods
- LSD type ball differentials (front & rear)
- front universal driveshaft & rear dog bones
- composite shock absorbers (with adjustable damping)
- front urethane bumper & rear bumper
- die-cast aluminum clamp type motor mount
- spur gear (70T)
- aluminum pinion gear (30T)
- ball bearings (9 pieces)

- realistically scale body
- GT wings (3D wing & double wing)
- highly detailed decals (lights, intercooler, rear tail lamps, window trim, etc.)
- YOKOMO metallic decals
- window paint masking
- accessory parts (polished performance exhaust muffler, brake rotors, brake calipers, wipers, aero mirrors)
- "ZERO-ONE" (patent pending) tires for unparalleled drift performance
- 10 spoke mesh or 6 spoke chrome metallic wheels (street version)
- SUPER ADVAN 3-spoke wheels and "ZERO-ONE R" (patent pending) tires included in HKS HIPER SILVIA kit only



One of the desired features of the 180SX, retractable headlights have also been included. In addition to the fully open and closed looks, the 'sleepy eye' look is also included for die-hard drift enthusiasts.



Kit includes polished performance exhaust mufflers. Choose from new and old style tail lamp decals for that JDM look.



Adjustable angle 3D and double-type GT wings included. The TOYOTA AE86 TRUENO kit also comes with a removable rear lip spoiler.



Detailed accessory parts including front and rear brake rotors, brake calipers, wipers and aero mirrors are included for added scale realism.



Patent pending ZERO-ONE drift tires. Optimal drift settings can be achieved by adjusting the number of rings and camber settings.

## NEW D1-SPEC HKS HIPER SILVIA RTD (READY-TO-DRIFT)

Introducing our all new line of D1-SPEC RTD (READY-TO-DRIFT) RC cars. Each comes with a factory pre-assembled chassis, installed electronics, pre-mounted drift tires and wheels, and a pre-painted body with decals and accessories.



## NEW D1-SPEC HKS HIPER SILVIA RS-2



## NEW D1-SPEC A'PEX D1 PROJECT FD3S

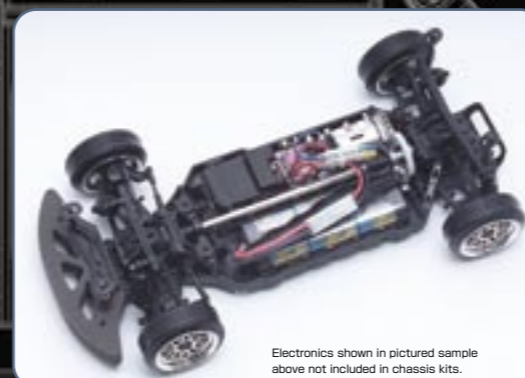

Electronics shown in pictured sample above not included in chassis kits.

PART NO.	PRODUCT DESCRIPTION	PRICE
DP-180SX	NEW DRIFT PACKAGE Kit with NISSAN 180SX Body	\$370.00
DP-AE86	NEW DRIFT PACKAGE Kit with TOYOTA AE86 TRUENO Body	\$370.00
DP-S15	NEW DRIFT PACKAGE Kit with NISSAN S15 SILVIA Body	\$370.00
DP-FC3S	NEW DRIFT PACKAGE Kit with MAZDA FC3S RX-7 Body	\$370.00
DP-HKS	NEW DRIFT PACKAGE D1-SPEC Kit with HKS HIPER SILVIA RS-2 Body	\$380.00
DP-APEX	NEW DRIFT PACKAGE D1-SPEC Kit with A'PEX D1 PROJ. FD3S Body	\$380.00

Additional items required: 2 channel radio system (transmitter, receiver, speed controller, servo), SUB-C type 7.2V battery (6 cell), charger, motor (Yokomo Drift Spec 21T or 35T motor recommended), polycarbonate paint.

## YOKOMO GT-4 SERIES

The original 60+ miles per hour GT-4 RTR that revolutionized the ready-to-run nitro class

# GT-4 RTR

This is it, the original 60+ miles per hour GT-4 RTR that revolutionized the ready-to-run nitro class. The same chassis and suspension design that won two ROAR National Titles, in addition to Canadian, British and South African Nationals. Factory assembled in Japan, factory tested by Yokomo USA and powered by an outlaw .18 pull start engine. Available with a choice of either a Porsche GT2 or VeilSide RX-7, our GT-4RTR now comes with our new Yokomo 2 channel dual rate 27MHz system installed and offers all the adjustability of a pro racer. Pivot ball suspension lets you tune your GT-4 RTR's camber. The 2 speed automatic is adjustable as well. You can even change the shock oil to vary dampening on different surfaces. Why settle for anything less than the best for your first nitro RC car? The GT-4RTR can also be retro-fitted to race with ROAR-legal .12-size engines and can be upgraded with Yokomo option parts.



PART NO.	DESCRIPTION	PRICE
GT4RTR1	GT-4RTR with PORSCHE 911 GT2 Body	\$580.00
GT4RTR2	GT-4RTR with VEILSIDE RX-7 Body	\$580.00
GT4RTR3	GT-4RTR with EURO RACING TRUCK Body	\$580.00

Additional items required: r/c car engine fuel, glow igniter, tire glue, polycarbonate paint, AA size alkaline batteries x 12.

The new GT-4 RTR II takes the Yokomo line of ready-to-race supercars to the next level.

# GT-4 RTR II

Everyone loved the GT-4 RTR, with its competition pedigree and in your face performance. The new GT-4RTRII takes the Yokomo line of Ready to Race supercars to the next level. The RTRII picks up where the RTR left off by adding our totally new .18 Yokomo rear exhaust engine breathing through an all new alloy tuned pipe. To handle the extra power of the new mill, there are mounted and glued Y-pattern radials on all four corners. To get you running even faster, we've factory pre-painted your choice of an officially licensed Porsche GT2 or HS-GT body. Finishing off the GT-4RTRII package is our new Yokomo two channel 27MHz system with dual rate steering control. Just add batteries, fuel and glow plug igniter, pull the starter and you are good to go with the only nitro-powered RTR touring car to win two ROAR National Championships.



PART NO.	DESCRIPTION	PRICE
GT4RTR21	GT-4RTR II with HS GT Body	\$680.00
GT4RTR22	GT-4RTR II with PORSCHE 911 GT2 Body	\$680.00

Additional items required: r/c car engine fuel, glow igniter, AA size alkaline batteries x 12.

The newest version of our 2-time ROAR National Champion.

# GT-4W2 LIMITED

The newest version of our 2-time ROAR National Champion, the GT-4W Version 2 is our best nitro touring car yet. Features all the good stuff, including low cg engine mounts and machined 7075 duralumin chassis, Centax-type clutch, shoe-type 2-speed, plus aluminum shock towers, aluminum radio plate supports and posts, aluminum brake support brace and side belt tensioner. The GT-4W Version 2 also includes our super smooth, precision machined pro shocks, mounted, glued and trued foam racing slicks, front universals and a high impact, lightweight urethane bumper. SG-type engine required.



PART NO.	DESCRIPTION	PRICE
GT4W2L	GT-4W2 LIMITED Kit	\$680.00







Additional items required: 2 channel radio system (transmitter, receiver, servo x 2), rechargeable 5-cell receiver battery, engine, exhaust manifold and pipe, glow igniter, engine starter box, r/c car engine fuel, touring car body (200mm), polycarbonate paint.

## KIT LISTING

PWR	CLASS	LEVEL	PART NO.	DESCRIPTION	PRICE	
GP	DRIFT Series	★★	DP-180SX	DRIFT PACKAGE STREET VERSION Kit with NISSAN 180SX Body	NEW \$370.00	
		★★	DP-AE86	DRIFT PACKAGE STREET VERSION Kit with TOYOTA AE86 TRUENO Body	NEW \$370.00	
		★★	DP-S15	DRIFT PACKAGE STREET VERSION Kit with NISSAN S15 SILVIA Body	NEW \$370.00	
		★★	DP-FC3S	DRIFT PACKAGE STREET VERSION Kit with MAZDA FC3S RX-7 Body	NEW \$370.00	
		★★	DP-HKS	DRIFT PACKAGE D1-SPEC Kit with HKS HIPER SILVIA RS-2 Body	NEW \$380.00	
		★★	DP-APEX	DRIFT PACKAGE D1-SPEC Kit with A'PEX D1 PROJECT FD3S Body	NEW \$380.00	
			★	DPR-180	DRIFT PACKAGE Limited Edition RTR with NISSAN 180SX Body (Custom Painted & Pre-Assembled)	NEW \$865.00
	EP	1/10 Touring	★★★	MRTC-SD7	MR-4TC SD CGM SPECIAL Chassis Kit	\$478.00
			★★★	MRTC-SD3	MR-4TC BLACK SPECIAL Chassis Kit	\$528.00
			★★★	MRTC-SD1	MR-4TC SD SSG SPECIAL Chassis Kit	\$528.00
			★	MRTC-RTR1	MR-4TC RTR with EURO RACING TRUCK Body (Pre-Assembled)	\$415.00
1/12 Touring		★★	MRTC-MD	MR-4TC MINI Kit with Stratus Mini Body	\$345.00	
1/10 OFF-Road		★★	MRBC-1	MR-4BC Standard Kit	\$280.00	
		★★★	MRBC-1S	MR-4BC SPECIAL Kit	\$499.00	
1/12 ON-Road Circuit Model	★★★★	YRX-12WE	YRX-12 World's Edition Kit with MS-1 Body	\$365.00		
1/10 ON-Road Circuit Model	★★★★	YRX-2000P	YRX-2000P Chassis Kit	\$417.00		
GP	DRIFT Series	★	ND-HKS	NITRO DRIFT D1-SPEC with HKS HIPER SILVIA RS-2 Body	\$525.00	
	1/10 Touring Circuit Model	★★★★	GT-4W2L	GT-4W2 Limited Edition Chassis Kit	\$680.00	
GP	1/10 Touring RTR Model	★	GT4RTR1	GT-4 RTR with RX-7 VeilSide Body (Pre-Assembled)	\$580.00	
		★	GT4RTR2	GT-4 RTR with PORSCHE 911 GT2 Body (Pre-Assembled)	\$580.00	
		★	GT4RTR3	GT-4 RTR with EURO RACING TRUCK Body (Pre-Assembled)	\$580.00	
		★	GT4RTR21	GT-4 RTR II with HS GT Body (Pre-Assembled)	\$680.00	
		★	GT4RTR22	GT-4 RTR II with PORSCHE 911 GT2 Body (Pre-Assembled)	\$680.00	







※ EP = Electric Powered ※ GP = Gas Powered ※ Fewer ★ s indicate easier assembly and usage, while more ★ s indicate a higher level of difficulty. ※ Body not included in chassis kits. Please purchase separately. ※ Special order items are normally not in stock. Availability is approximately 4 weeks from time of order.

## DRIFT BODIES & ACCESSORIES

	PART NO.	DESCRIPTION	WIDTH	PRICE
	SD-180BS	<b>NISSAN 180SX Street Version Bod</b> Aero mirror & wiper set, muffler set, GT wing set, detailed headlight/taillight decals and window masking included.	195mm	\$48.00
	SD-AE86BS	<b>TOYOTA AE86 Street Version Body</b> Aero mirror & wiper set, muffler set, GT wing set, detailed headlight/taillight decals and window masking included.	195mm	\$48.00
	SD-S15BS	<b>NISSAN S15 SILVIA Street Version Body</b> Aero mirror & wiper set, muffler set, GT wing set, detailed headlight/taillight decals and window masking included.	190mm	\$48.00
	SD-FC3SBS	<b>MAZDA FC3S RX-7 Street Version Body</b> Aero mirror & wiper set, muffler set, GT wing set, detailed headlight/taillight decals and window masking included.	190mm	\$48.00
	SD-HKSBS	<b>HKS HIPER SILVIA RS-2 D1-SPEC Body</b> Aero mirror & wiper set, muffler set, GT wing set, detailed headlight/taillight decals and window masking included.	190mm	\$48.00
	SD-APEXBS	<b>A'PEX D1 PROJECT FD3S D1-SPEC Body</b> Aero mirror & wiper set, muffler set, GT wing set, detailed headlight/taillight decals and window masking included.	190mm	\$TBA
	SD-ACD	<b>Aero Mirror &amp; Wiper Set</b> Two mirrors and three wipers included per set.		\$3.50
	SD-ACM	<b>Muffler Set</b> Two exhaust mufflers and mounting hardware included.		\$6.25
	SD-ACW	<b>GT Wing Set</b> Set includes adjustable angle 3D and double-type GT wings with mounts.		\$6.25

※ Painted samples pictured above. Actual products are clear and unpainted.

## BODIES

	PART NO.	DESCRIPTION	WIDTH	PRICE
	ZR-YSBE	<b>The ultimate touring car body for racing !!</b> <b>Stratus Type-E Body</b> The overall high downforce design of this 5th generation body provides quick, responsive steering while keeping the rear end planted. High downforce step wing included. Lightweight racing version. Detailed headlight/taillight decals and window masking included	For EP Touring Cars 190mm Wide	\$21.95
	RS-26	<b>RAYSPPEED ACCORD(TSX) Body</b> Designed and tested by Team Yokomo ace driver Shinnosuke Adachi. Features high body rigidity, quick response and high stability. Enables even small corners to be rounded smoothly. Detailed headlight/taillight decals and window masking included.	For EP Touring Cars 190mm Wide	\$21.95
	SP-12MS1	<b>MS1 1/12th Scale Racing Body</b> Overall high downforce body suitable for all conditions. Used by Masami Hirosaka to tq and win the 2002 IFMAR World Championships.	For EP 1/12th Scale Cars	\$16.25
	SP-12MS2	<b>MS2 1/12th Scale Racing Body</b> Features an extremely low profile design for quick, responsive handling. Developed and tested by 1/12th World Champion Masami Hirosaka.	For EP 1/12th Scale Cars	\$16.25
	ZE-RTB	<b>GT-1 Outlaw Body</b> High downforce racing body for the Outlaw class. Features an open cockpit design.	For GP Touring Cars 200mm Wide	\$25.00
	ZE-RHB	<b>GT-P Outlaw Body</b> High downforce racing body for the Outlaw class. Features a closed cockpit design.	For GP Touring Cars 200mm Wide	\$25.00
	RD-1003	<b>Realistically scale !!</b> <b>PORSCHE 911 GT2 Body</b> Officially license product. Detailed headlight and taillight decals and window masking included.	For EP Touring Cars 190mm Wide	\$25.00
	RD-1004		For GP Touring Cars 200mm Wide	\$25.00
	ZR-RTHB	<b>Euro Racing Truck Body</b> This realistically scale 4 piece body is compatible with most touring cars. Detailed headlight/taillight decals and window masking included.	For EP Touring Cars 190mm Wide	\$42.50
	ZE-RTHB	※ Due to the limited number of possible body mounting positions, this body may not be compatible with body post configurations on some chassis makes.	For GP Touring Cars 200mm Wide	\$42.50

※ Painted samples pictured above. Actual products are clear and unpainted.

## TOURING CAR TIRES

PART NO.	DESCRIPTION	SHAPE · CHARACTERISTICS	COMPOUND	TEMP. RANGE	WIDTH	QTY	PRICE
ZR-138M2	<b>BELTEC 5M Slick Tires</b> Perfect for cold weather racing	 <p>One of the best selling touring car racing tires to have hit the R/C market. Having won numerous national titles, the G-compound Beltec 5 was selected as the control tire for the 2000 IFMAR World Championships. Features a long wear carcass.</p>	M (Soft)	32 ~ 34°F	24mm	4	\$28.50
ZR-138B2	<b>BELTEC 5B Slick Tires</b> Long wear cold weather racing tire		B (Soft)	42 ~ 77°F	24mm	4	\$28.50
ZR-138G2	<b>BELTEC 5G Slick Tires</b> Works well on most tarmac surfaces		G (Med)	59 ~ 95°F	24mm	4	\$28.50
ZR-138GF2	<b>BELTEC 5GF Slick Tires</b> Great for hot weather GP touring car racing		GF (Firm)	86 ~ 122°F	24mm	4	\$28.50
ZR-138GH2	<b>BELTEC 5GH Slick Tires</b> Great for hot weather GP touring car racing		GH (Hard)	104 ~ 140°F	24mm	4	\$28.50
GR-102G	<b>Pre-Mounted 5G Tires</b> Pre-mounted on white TW-0512-2 wheels		G (Med)	59 ~ 95°F	24mm	4	\$44.50
ZR-139M2	<b>BELTEC 7M Slick Tires</b> Perfect for cold weather racing	 <p>Our most recently developed racing tire with the same contour as the Beltec 5 tire, but lighter in weight for quicker response. Use with lightweight inserts and wheels to further reduce rotational weight, and improve acceleration.</p>	M (Soft)	32 ~ 65°F	24mm	4	\$31.00
ZR-139B2	<b>BELTEC 7B Slick Tires</b> Long wear cold weather racing tire		B (Soft)	41 ~ 68°F	24mm	4	\$30.00
ZR-139GS2	<b>BELTEC 7GS Slick Tires</b> One step softer than the G-compound.		GS (Soft)	50 ~ 77°F	24mm	4	\$28.50
ZR-139G2	<b>BELTEC 7G Slick Tires</b> Works well on most tarmac surfaces		G (Med)	59 ~ 95°F	24mm	4	\$28.50
ZR-139GF2	<b>BELTEC 7GF Slick Tires</b> Great for hot weather GP touring car racing		GF (Firm)	86 ~ 122°F	24mm	4	\$28.50
GR-101G	<b>Pre-Mounted P3 Tires</b> Pre-mounted on grey TW-1213S-2 wheels		 <p>Works well on both dusty and wet surface conditions. Realistic tread pattern.</p>	<b>Non-Belted</b>		26mm	4
ZR-080D	<b>P3 Type-D Radial Tires</b> Specially formulated compound for drifting	<b>Non-Belted · D Compound</b>		26mm	4	\$12.50	
GR-102G	<b>Pre-Mounted R03 Tires</b> Pre-mounted on grey TW-1213S-2 wheels	<b>Non-Belted · N Compound</b>		26mm	4	\$29.50	
GR-102W	<b>Pre-Mounted R03 Tires</b> Pre-mounted on white TW-1213-2 wheels	<b>Non-Belted · N Compound</b>		26mm	4	\$29.50	
ZR-R03D	<b>R03 Type-D Radial Tires</b> Specially formulated compound for drifting	<b>Non-Belted · D Compound</b>		26mm	4	\$12.50	
		<b>Non-Belted · D Compound</b>		26mm	4	\$12.50	

### Tire Temperature & Traction Relationship (Not using tire warmers.)

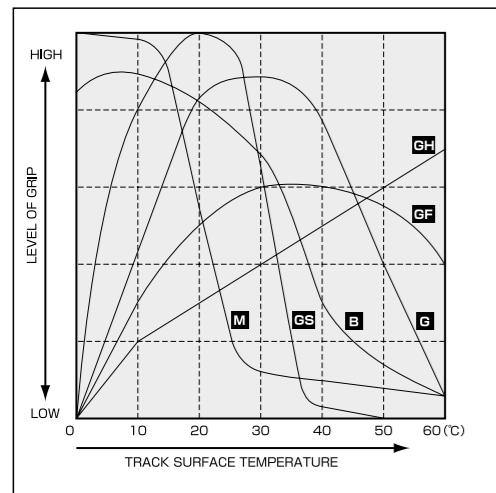

#### M Compound

Our best winter racing compound. Even at track temperatures of only 32 degrees, this revolutionary compound provides maximum traction without the use of tire warmers. Light weight rubber helps improve runtime. Due to the fast wearing nature of the compound, use with stock motors recommended.

#### B Compound

A long wear winter racing compound. Improvements in wear normally result in reduced grip, but this compound has very well balanced wear and grip characteristics. Highly recommended for those who prefer the feel of M compound tires. A unique characteristic of this compound is that even when overheated, the tires are unlikely to cause the car to spin out. In most cases, a tire warmer is not necessary, but if the tires lack grip in the beginning, but gain grip while running, tire warmers are recommended. In all other cases, using a tire warmer may actually cause the tire to overheat, and is not recommended.

#### GS/G Compound

Works very well with EP touring cars on most track surfaces. Both GS and G compounds are based on the same compound. G is standard, and GS is a more high grip, fast wearing compound.

#### GF/GH Compound





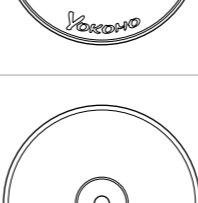
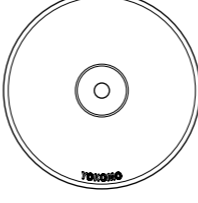
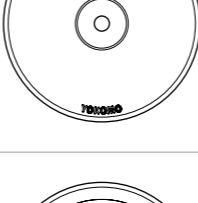
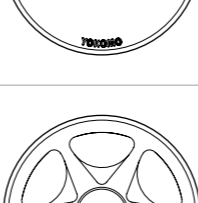
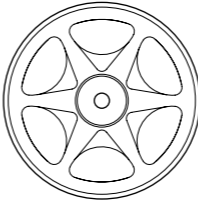
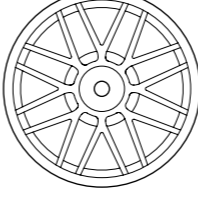
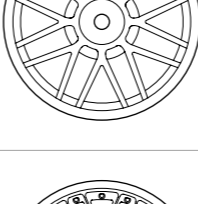
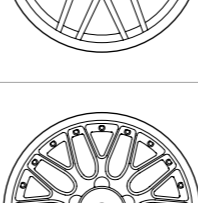
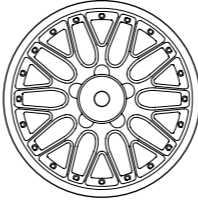
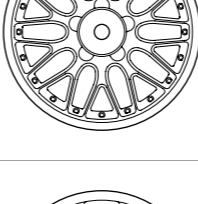
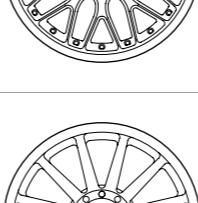
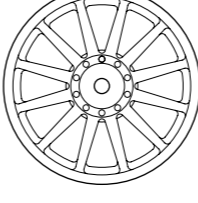
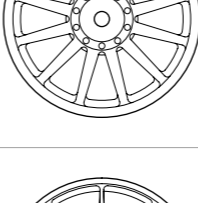
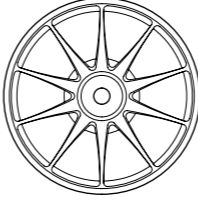

Works very well with GP touring cars. Both GF and GH compounds are based on the same compound.

## TOURING CAR WHEELS

PART NO.	DESIGN	DESCRIPTION	WIDTH	MATERIAL	OFFSET	QTY	PRICE
TW-1012-2		<b>The ultimate wheel for touring car racing !!</b> <b>Super Precision Aero Dish Wheel</b> Manufactured using a precision injection molding process, these wheels have unparalleled balance, trueness, rigidity, and light weight.	24mm	ABS (White)	0 Offset	4	\$8.00
TW-1012Y2		Used to win both 2002 and 2003 JMRC Japan National Championships. Also available in bright yellow for high visibility.	24mm	ABS (Yellow)	0 Offset	4	\$8.00
TW-0512-2		<b>Aero Dish Wheel</b> Used to win the 2000 IFMAR World Championships. Strong and durable.	24mm	ABS (White)	0 Offset	4	\$8.00
TW-0312-2			24mm	Nylon (White)	0 Offset	4	\$8.00
TW-0512A2			24mm	ABS (White)	For RC10TC3	4	\$8.00
TW-0612-2		<b>6 Spoke Wheel</b> Used to win the 2001 Super Stock Touring Car Championship held in Japan. Lightweight version. Recommended for performance minded enthusiasts looking for a wheel with a good combination of both speed and looks.	24mm	ABS (White)	0 Offset	4	\$8.00
TW-0112-2			24mm	ABS (White)	0 Offset	4	\$8.00
ZR-0112-2		<b>8 Spoke Mesh Wheel</b> High strength design for improved durability. Available for both MR-4 and YR-4 series cars.	24mm	ABS (White)	2 Offset	4	\$8.00
TW-0113-2			26mm	ABS (White)	0 Offset	4	\$8.00
TW-1213-2			26mm	Nylon (White)	0 Offset	4	\$8.00
TW-1213S-2		<b>10 Spoke Mesh Wheel</b> Very durable wheel designed for GP touring cars. (Included in select GT-4 kits.) Available in white, grey and chrome.	26mm	Nylon (Grey)	0 Offset	4	\$8.00
TW-1213C-2			26mm	Nylon (Chrome)	0 Offset	4	9.50
TW-0212-2			24mm	Nylon (White)	0 Offset	4	\$8.00
TW-0213-2		<b>12 Spoke Wheel</b> Durable wheel designed for GP touring cars.	26mm	Nylon (White)	0 Offset	4	\$8.00
ZR-0492-2		<b>10 Spoke Wheel</b> Endurance racing wheel designed for YR-4 series cars.	24mm	ABS (White)	2 Offset	4	\$8.00

○ ABS = Material with high rigidity. Recommended for racing. ○ Nylon = Strong and durable material. Recommended for GP touring cars or practice use.  
○ 0 Offset = Compatible with MR-4TC series and GT-4 series cars. ○ 2 Offset = Compatible with YR-4 series cars.

## TOURING CAR TIRE INSERTS

PART NO.	DESCRIPTION	SHAPE	HARDNESS	WIDTH	QTY	PRICE
ZR-039M	<b>Super Thin Molded Inserts</b> Suitable for high traction surfaces. Helps prevent traction rolling. Ideal tire diameter : 64mm front/rear		Medium	24mm	2	\$3.75
ZR-039F			Firm	24mm	2	\$3.75
ZR-037S	<b>Thin Molded Inserts</b>		Soft	24mm	2	\$3.75
ZR-037M	Suitable for medium grip surfaces. Reknown for setting the standard in molded inserts. Ideal tire diameter : 64mm front/rear		Medium	24mm	2	\$3.75
ZR-037F			Firm	24mm	2	\$3.75
ZR-036M	<b>Thick Molded Inserts</b>		Medium	24mm	2	\$3.75
ZR-036F	Suitable for low traction surfaces. Helps prolong tire life. Ideal tire diameter : above 64mm		Firm	24mm	2	\$3.75
ZR-038M	<b>Thin Molded Inserts</b>		Medium	26mm	2	\$3.75
ZR-038F	Suitable for medium grip surfaces.		Firm	26mm	2	\$3.75
ZR-034F	<b>Standard Foam Inserts</b> Works well in conditions where molded inserts may not work as well, such as bumpy, high traction surfaces.		Firm	24mm	2	\$3.75
ZR-034			Medium	26mm	2	\$2.00



Pictured: prototype gas car driven by Masami Hirotsuka of Team Yokomo at the 2003 JMRCA Japan National Championship.

## TOURING CAR TIRE ACCESSORIES

PART NO.	DESCRIPTION	PRICE
YT-PTW	<p><b>PRO Tire Warmer</b></p> <p>Unleash the full potential of your tires with the ultimate tire warmer !!</p> <p>Undoubtedly the ultimate touring car tire warmer, jointly developed by Team Yokomo and Team Sorex.</p> <p>○ Input power source: DC12V or 7.2V battery (that can be installed inside the unit) ○ Set target temperatures individually for the front and rear, between 5.0 ~ 80.0 °C (45 °C maximum when using a battery). Unit will automatically maintain tires at their set target temperature. ○ Back lit LCD screen accurately displays temperature readings from all four tires in real time. ○ Heats quickly (requires only 5 minutes to warm tires from 25°C to 80 °C ). ○ Convenient built-in timer feature. ○ Metal warming Cup are an exact fit for Yokomo and Sorex tires. ○ Durable construction.</p>	\$349.50
YT-TSM	<p><b>Tire Sander</b></p> <p>Designed to work with 1/10th scale touring car rubber tires. Using a piece of sanding paper, thin lips or projections that occur at the tire's mold parting line can be removed. This unit can also be used to refresh the tread surface of tires that have already been run. DC12V power supply required. Sanding paper sold separately.</p>	\$90.75
TN-1	<p><b>TN-1 Infrared Temperature Gauge</b></p> <p>Make the right tire choice by accurately measuring track temperature !!</p> <p>A compact temperature gauge that accurately measures the surface temperature of objects without having to touch them. Use to measure track temperature, engine/motor temperature, battery temperature. Can also be used as a kitchen tool to measure frying oil temperature, frying pan temperature, etc.</p> <p>○ measuring range: -33 ~ +220 °C ○ measuring variance: ± 2 °C ○ reflectance: 0.95 (adjustable) ○ battery: CR2032 (included) ○ size: 18 × 37 × 68mm ○ weight: 32g (including battery) ○ storage case, strap, and extra battery included.</p>	\$65.00

## GP TOURING CAR FOAM TIRES

PART NO.	SIZE	COMPOUND (MATERIAL)	SHORE	QTY	PRICE	
ST-A260M	Compatible with most GP touring cars Front (26mm wide)	Type-A Rubber (Low Wear Foam)	Medium	35'	2	\$19.95
ST-A260MF		Perfect for front tire use, this compound has very good wear characteristics.	Medium Firm	38'	2	\$19.95
ST-A260F			Firm	41'	2	\$19.95
ST-A260H			Hard	45'	2	\$21.95
ST-L260M	For the GT-4 Rear (30mm wide)	Type-L Rubber (Standard Foam)	Medium	35'	2	\$18.50
ST-L260MF		This compound has very high grip, perfect for rear tire use.	Medium Firm	38'	2	\$18.50
ST-L260F			Firm	41'	2	\$18.50
ST-L260H			Hard	45'	2	\$20.50
ST-L300M	Compatible with most GP touring cars Rear (30mm wide)	Type-L Rubber (Standard Foam)	Medium	35'	2	\$19.50
ST-L300MF			Medium Firm	38'	2	\$19.50
ST-L300F		The multi-ring construction provides improved durability.	Firm	41'	2	\$19.50
ST-L300H			Hard	45'	2	\$21.50
SM-L300M		Type-L Multi-Ring Rubber (Standard Foam)	Medium	35'	2	\$19.95
SM-L300MF			Medium Firm	38'	2	\$19.95
SM-L300F		The multi-ring construction provides improved durability.	Firm	41'	2	\$19.95
SM-L300H			Hard	45'	2	\$21.95
ST-L303M		Type-L Rubber (Standard Foam)	Medium	35'	2	\$19.50
ST-L303MF			Medium Firm	38'	2	\$19.50
ST-L303F			Firm	41'	2	\$19.50
ST-L303H			Hard	45'	2	\$21.50
SM-L303M		Type-L Multi-Ring Rubber (Standard Foam)	Medium	35'	2	\$19.95
SM-L303MF			Medium Firm	38'	2	\$19.95
SM-L303F		The multi-ring construction provides improved durability.	Firm	41'	2	\$19.95
SM-L303H			Hard	45'	2	\$21.95

○ Approximate tire diameter: 64mm ○ Lower shore rating numbers indicate higher grip, higher numbers indicate less grip. ○ Use firm (41' shore) as a starting point.







## BATTERIES (SUB-C RECHARGEABLE TYPE)

PART NO.	DESCRIPTION	PRICE
YB-R36B	 <b>NEW</b> Yokomo R3600HVC ZAP2 6 Cell Unassembled Pack All new high capacity R3600HVC cells that have been treated with our voltage enhancing ZAP2 process. Battery bars included.	\$78.00
YB-R36B24	 <b>NEW</b> Yokomo R3600HVC ZAP2 24-Cell Unassembled Brick Pack All new high capacity R3600HVC cells that have been treated with our voltage enhancing ZAP2 process. Economical 24-cell brick pack.	\$295.00
YB-R36P	 <b>NEW</b> Yokomo R3600HVC ZAP2 6-Cell Assembled Stick Pack All new high capacity R3600HVC cells that have been treated with our voltage enhancing ZAP2 process. Compared to connectors on most standard stick packs, our packs feature gold plated connector terminals and super-flex 14 gauge silicone wire for reduced resistance, resulting in improved power and runtime performance.	\$87.00
YB-Z33B	 Yokomo Z3300HVR ZAP2 6-Cell Unassembled Pack High voltage Z3300HVR cells that have been treated with our voltage enhancing ZAP2 process. Battery bars included.	\$59.00
YB-Z33B24	 Yokomo Z3300HVR ZAP2 24-Cell Unassembled Brick Pack High voltage Z3300HVR cells that have been treated with our voltage enhancing ZAP2 process. Battery bars included. Economical 24-cell brick pack.	\$255.00
YB-Z33P	 Yokomo Z3300HVR ZAP2 6-Cell Assembled Stick Pack High voltage Z3300HVR cells that have been treated with our voltage enhancing ZAP2 process. Compared to connectors on most standard stick packs, our packs feature gold plated connector terminals and super-flex 14 gauge silicone wire for reduced resistance, resulting in improved power and runtime performance.	\$TBA

\* Unassembled packs are assembled by soldering the battery bars to the cells. Previous soldering experience is required to complete this task. If you are new to the hobby, we recommend using our pre-assembled stick pack batteries.

## MATCHED BATTERIES (SUB-C RECHARGEABLE TYPE)

Having won numerous World Championships using our proprietary matching system, we have upgraded to a new matching system for the 2004 racing season. Vital cell data recorded during the matching process is now printed on each cell, such as discharge time(SEC), average discharge voltage(Vts), peak voltage(P/V), charge time(CHG TIME), discharge cut-off(Cutt Off), internal resistance(I-Res), charge amperage(Chg), and discharge amperage(Dis). \* Discharge data based on discharge rate of 30A.

PART NO.	DESCRIPTION	PRICE
YB-R36SG1	 <b>NEW</b> PEAK MATCHED R3600HVC SG1 6-Cell Unassembled Pack Top grade high performance matched packs. Silver battery bars also included. Performance data not available at this time.	\$TBA
YB-Z33SG1	 PEAK MATCHED Z3300HVR SG1 6-Cell Matched Unassembled Pack High performance matched packs. All packs feature discharge times of 400+ seconds, and average discharge voltage of 1.170V and up. Battery bars also included.	\$115.00
YB-Z33SG2	 PEAK MATCHED Z3300HVR SG2 6-Cell Unassembled Pack Runtime-oriented high performance matched packs featuring 420+ second discharge times and 1.163V and higher average discharge voltage. Battery bars also included.	\$90.00
YB-Z33G3	 Z3300HVR G3 6-Cell Unassembled Pack High grade unmatched zapped cells. These are cells that were extracted out of the process because not enough matching cells were found. Battery bars also included.	\$75.00

\* The unassembled packs and PEAK MATCHED packs are assembled by soldering the battery bars to the cells. Previous soldering experience is required to complete this task.

## BATTERY

Take your racing to the next level  
with Yokomo original battery cells.



High performance racing batteries have always been an integral part of Electric RC car racing. Recent years have witnessed tremendous gains in battery performance, especially the Z3300HVR cell, which has evolved into one of the best performing cells in regards to both power(voltage) and run-time(capacity). The newest TYPE-R version of the Z3300HVR cell features even better performance, with an unparalleled combination of power and run-time. Even under the restrictions set forth by the race-sanctioning bodies, the SUB-C type battery has seen an enormous leap in performance. And just as one begins to wonder if further improvements are even possible, new batteries with enhanced characteristics are released. Such is the new R3600HVC cell, with incredibly longer run times. Like the Z3300HVR cells these have been ZAP 2 processed for maximum performance.

Whether your battery requirements are high voltage for stock motor racing, or long run-time for 4-cell modified racing, we have the batteries to help you take your racing to the next level.



Ni-MH

## BATTERY ACCESSORIES

PART NO.	DESCRIPTION	QTY	PRICE
YB-SB	Battery Bars (For R3600HVC/RC3300HV)	10	\$11.50
YB-SB25	Battery Bars (For R3600HVC/RC3300HV)	25	\$29.50
YB-SBS	Silver Battery Bars (For Z3300HVR Cells)	10	\$12.50
YB-SBS25	Silver Battery Bars (For Z3300HVR Cells)	25	\$30.50
YB-SBL	Pre-Bent L-Shaped Silver Battery Terminals	6	\$8.25
YB-MST	Matched Battery Safety Shielding Tape		\$1.75
YW-14RB	Silicone Wire 14GA (Red · Black)		\$12.50
YW-12RB	Silicone Wire 12GA (Red · Black)		\$12.50

Manufacturer's Suggested Retail Prices listed. Contact your local Yokomo retailer for current prices.

## CHARGERS / DISCHARGERS

PART NO.	PICTURE	DESCRIPTION						PRICE
		INPUT	COMPATIBLE BATTERY	CHG(A)	DIS(A)	CASE SIZE	WT	
YZ-183AD		<b>NEW YZ-183A/D Charger/Discharger</b> Featuring a built-in power supply, and capable of operating on either AC110V or DC12V, the versatility of this unit allows it to be used almost anywhere. Both the charge and discharge functions have numerous adjustable settings, including delta peak cut-off voltage (1 ~ 15mV), and discharge amperage (up to 30A). A charge/discharge cycling function is also available for battery management. Compatible with both NiCd and NiMH cells, and capable of handling 1 ~ 8 cells. Unit also features a large size back lit LCD screen to accurately display charge/discharge data. Output leads with alligator clips included.						\$350.00
		AC110V DC12V	SUB-C type NiCd and NiMH 1 ~ 8 cell 50 ~ 6000mAh	0.1 ~ 6.5A	0.1 ~ 30A	150 x 189 x 77mm	900g	
YZ-114AD		<b>NEW YZ-114A/D Charger/Discharger</b> This compact, portable unit features a built-in power supply, and is capable of operating on either AC110V or DC12V, which allows it to be used almost anywhere. Features easy-to-use charge, discharge, and cycle functions. Capable of charging 1 ~ 14 cells, including radio transmitter batteries, receiver batteries, and rechargeable glow igniter batteries. LCD screen accurately displays charge and discharge data in real time. Safety features include: a reverse polarity protection fuse, and an internal cooling fan. Output leads sold separately.						\$230.00
		AC110V DC12V	NiCd and NiMH 1 ~ 14 cell 270 ~ 4500mAh	0.5 ~ 5.5A	0.6 ~ 4A (Auto)	150 x 129 x 71mm	596g	
YZ-48D		<b>NEW YZ-48D Charger/Discharger</b> Features easy-to-use charge, discharge, and cycle functions. Capable of charging 4 ~ 8 cells, including radio transmitter and receiver batteries. LCD screen accurately displays charge and discharge data in real time. Safety features include: a reverse polarity protection fuse, and an internal cooling fan. Output leads sold separately.						\$155.00
		DC12V	NiCd and NiMH 4 ~ 8 cell 270 ~ 4500mAh	0.5 ~ 5.5A	2 ~ 4A (Auto)	150 x 129 x 71mm	396g	
EP-046		<b>EP MATE 046 Discharger</b> Press the red button and this multi-function unit will automatically discharge/condition the battery while monitoring both voltage and capacity. Automatically switches from a 5A discharge to a 1A discharge to condition the battery. 6 cell and 4 cell compatible. Large size LCD screen displays both voltage and discharge data by switching the data shown every 3 seconds. Lead with 7.2V Tamiya connector included.						\$68.00
		None	SUB-C type NiCd and NiMH 4 cell or 6 cell	—	5/1A	102 x 80 x 30mm	165g	
RS-16		<b>RAYSPEED EXCEED Discharge Tray</b> Designed by Japanese National Champion and World's A-finalist, Shinnosuke Adachi. This racing battery conditioner features an equalizing and conditioning mode to help maintain racing batteries in top condition. Compatible with both NiCd and NiMH cells. Discharge cut-off voltage for NiMH is 0.9V, and 0.1V for NiCd cells. Input leads with alligator clips included.						\$69.50
		DC12V	SUB-C type NiCd and NiMH 4 cell or 6 cell	—	5/1A	161 x 98 x 47mm	440g	

\* External cables or leads not included in dimensions.





## CHARGER / DISCHARGER ACCESSORIES

PART NO.	DESCRIPTION	QTY	PRICE	PART NO.	DESCRIPTION	QTY	PRICE
YZ-M5L	Silicone Wires with Alligator Clips		\$6.00	YZ-F1	10A Fuse (YZ-114A/D · YZ-48D)		\$2.50
YZ-M7	Tx Charging Jack (KO · Futaba · Sanwa)		\$6.50	YZ-CF	Micro Cooling Fan Small (12V)		\$28.50
YZ-M8	Tx Charging Jack (JR)		\$6.50	YZ-CFL	Micro Cooling Fan Large (12V)		\$29.00
YZ-M6	Input Adapter with Alligator Clips		\$25.00	YW-14RB	Silicone Wire 14GA (Red · Black)		\$12.50
YZ-BM1	Charging Leads (For BMS · BCS)		\$8.50	YW-12RB	Silicone Wire 12GA (Red · Black)		\$12.50
YZ-BM2	Temp. Sensor (For BMS · BCS DOUBLE)		\$9.00				
YZ-BM3	Temperature Sensor (For BCS-S)		\$9.00				

Manufacturer's Suggested Retail Prices listed. Contact your local Yokomo retailer for current prices.

## MOTORS

PART NO.	PICTURE	DESCRIPTION	TURN(T) / WIND	BRUSH	TIMING	PRICE	
YM-ZT4212		<b>ZERO T-SERIES Hand-Wound Modified</b>	12T				
YM-ZT5210		The increased capacity of batteries have led to racing motors often being overloaded, causing them to overheat. The new ZERO T-SERIES motors feature precision machined aluminum endbells for highly improved heat dissipation, armatures with cooling fins, and cooling holes optimally located on the motor can to help keep the motor run cool and draw the most performance possible from the motor.	10T				
YM-ZT511			11T				
YM-ZT6207			7T				
YM-ZT6208		The T4 model is available with a 12T double-wind armature with a small-sized commutator and a 3mm core for high rpms. (Gear this motor as you would a 10T.)	8T	Double	Standard	12' (Open)	\$TBA
YM-ZT6209		The T5 model is available with either a 10T or 11T double-wind armature with a medium-sized commutator and a 5mm core for high torque.	9T				
YM-ZT6210			10T				
YM-ZT6211		The T6 model is available with 7T through 12T double-wind armatures with a small-sized commutator and a 5mm core for a good balance of both rpm and torque. (This model is suitable for all types of racing categories.)	11T				
YM-ZT6212			12T				
YM-ZSW208			<b>ZERO S-WORLD Hand-Wound Modified</b>	8T			\$95.00
YM-ZSW209	Jointly developed with world reknown motor tuner Mike Reedy. Specifically designed to provide exceptional power and runtime, this motor features the all-new third generation ZERO can with a precision balanced hand-wound armature.		9T	Double	Standard		\$95.00
YM-ZSW210			10T			12' (Open)	\$95.00
YZ-ZSW2094			9T				\$95.00
YZ-ZSW2104		<b>ZERO S-WORLD 4M Hand-Wound Modified</b>	10T			\$95.00	
YZ-ZSW2114		Four magnet version of the ZERO S-WORLD. Due to the extremely high rpm nature of this motor, gear this motor as you would gear a motor with two less turns.	11T	Double	Standard		\$95.00
YZ-ZSW2124			12T				\$95.00
YM-PS21		<b>DRIFT-SPEC</b>	21T	Single		15' (Fixed)	\$38.00
YM-PS35	Specially designed to provide a more suitable motor for drifting. The lower turn 21T motor will provide more power, but will not have the same runtime as the higher turn 35T motor.	35T	Single	Standard		\$38.00	

\* Laydown type motors are more likely to emit noise that may cause radio interference. Use of more than one schottky diode may be required in some cases.

PART NO.	DESCRIPTION	PRICE	PART NO.	DESCRIPTION	QTY	PRICE
YM-ZAA207	S-WORLD Hand Wound Armature 7T Double	\$30.00	YM-081	High Power Motor Brush (Standard)	1 set	\$4.00
YM-ZAA208	S-WORLD Hand Wound Armature 8T Double	\$30.00	YM-081-5		5 set	\$18.75
YM-ZAA209	S-WORLD Hand Wound Armature 9T Double	\$30.00	YM-091L	High Power Motor Brush (Laydown)	1 set	\$4.00
YM-ZAA210	S-WORLD Hand Wound Armature 10T Double	\$30.00	YM-091L-5		5 set	\$18.75
YM-ZAA211	S-WORLD Hand Wound Armature 11T Double	\$30.00	YM-SD1	Schottky Diode	1	\$2.00
YM-ZAA212	S-WORLD Hand Wound Armature 12T Double	\$30.00	YM-CF	Clamp Type Noise Filter	1	\$9.00
YM-ZAA213	S-WORLD Hand Wound Armature 13T Double	\$30.00	YM-USD	Ultra Schottky Diode	1	\$20.00
YM-ZAA214	S-WORLD Hand Wound Armature 14T Double	\$30.00	YM-HFC	Motor Capacitors	3	\$1.25
YM-ZAA215	S-WORLD Hand Wound Armature 15T Double	\$30.00	YM-UHFC	Ultra Motor Capacitors	3	\$3.25
			YT-FCS	Noise Killer (Anti-Glitch) Kit	1 set	\$20.00



## MOTOR TUNING DEVICES

PART NO.	PICTURE	DESCRIPTION	PRICE
YZ-MMS		<b>MMS Motor Tuner</b> Multi-function motor tuner capable of monitoring vital motor data, breaking in motors, measuring rpm, and checking the condition of a motor. Voltage is adjustable from 0 ~ 8V. The RPM meter is capable of measuring unloaded motor rpm from 100 ~ 99,900 rpms. The condition meter (bar graph display) indicates real-time motor condition. A two line LCD screen is used to display all data simultaneously. Screen is back lit for visibility in dark areas. Compact design features a foldable screen (which protects the screen while transported.) ■ display: back lit LCD screen (displays voltage, current draw, rpm, condition) ■ additional items: RPM sensor motor plug ○ input power source: DC12V ○ compatible motors: 7T or higher (10A max.) ○ output voltage: 0.00 ~ 8.00V (adjustable) ○ size: 158 × 97 × 37mm ○ weight: 425g (including cables)	\$180.00
YZ-HMM		<b>Hyper Motor Mate</b> Small sized motor break-in tool capable of handling high current loads. Capable of handling a load up to 30A, this unit can be used to break in high power low turn modified motors. Voltage to the motor is adjustable from 0 ~ 7.5V. This versatile unit has many other uses, such as breaking in drivetrains, powering commutator lathes, or powering rubber tire sanders. ○ input power source: DC12V ○ compatible motors: 6T or higher (30A max.) ○ output voltage: 0.0 ~ 7.5V (adjustable) ○ size: 97 × 69 × 34mm ○ weight: 200g (including cables)	\$74.50
YM-RPM		<b>M-RPM Motor RPM Meter</b> Specifically designed to work with R/C motors (3 pole DC motors), this unit easily measures motor rpm without having to physically attach the meter to the motor. All that is required is to place the motor can near the sensor on the meter, and the motor rpm will be displayed. Capable of measuring 0 ~ 99999 rpm. ○ input power source: 9V battery (included) ○ size: 96 × 69 × 28mm ○ weight: 136g (battery included)	\$175.00
YM-TM		<b>Tesla Meter (Magnetometer)</b> A precision magnetometer featuring a Hall sensor. A Tesla(T) is a unit of magnetic field strength in the International System of Units. For example, 50mT(milli-Tesla) indicates that there are 500 magnetic field lines in an area of 1cm <sup>2</sup> . 1mT(milli-Tesla) is equal to 10G(Gauss). This unit will display the magnetic field strength measurement in mT(milli-Tesla) units. ○ input power source: 9V battery (included) ○ size: 96 × 69 × 28mm ○ weight: 146g (battery included)	\$168.00
YZ-MM1		RPM Sensor (For MMS)	\$15.50
YZ-MM2		RPM Sensor Motor Plug (For MMS)	\$3.00

Manufacturer's Suggested Retail Prices listed. Contact your local Yokomo retailer for current prices.



## RAYSPEED PRODUCTS

PART NO.	PICTURE	DESCRIPTION	SPECIFICATION / COMPATIBILITY	QTY	PRICE
RS-01		RAYSPEED Low Friction O-Rings	Compatible with 3mm shock shafts.	8	\$3.50
RS-02		RAYSPEED Silicone Bladder with Rebound Foam	Yellow / For low grip surfaces	4	\$5.25
RS-03		The bladders are available in 3 different hardnesses to work with a variety of surface conditions.	White / For most surface conditions	4	\$5.25
RS-04		Blue / For high traction surfaces	4	\$5.25	
RS-05		Yellow / Spring rate: 15 lbs/inch	2	\$5.25	
RS-06		RAYSPEED Shock Springs (1" Long Type)	White / Spring rate: 17 lbs/inch	2	\$5.25
RS-07		The longer spring length provides a more progressive spring. Available from blue to gray (in order of stiffness).	Red / Spring rate: 18 lbs/inch	2	\$5.25
RS-08		Gray / Spring rate: 20 lbs/inch	2	\$5.25	
RS-09		The RS-15 spring retainers are required when using these springs with Yokomo shocks and shock ends.	Blue / Spring rate: 14 lbs/inch	2	\$5.25
RS-10		Green / Spring rate: 13 lbs/inch	2	\$5.25	
RS-11		RAYSPEED Shock Pistons (For Yokomo Pro Shocks)	Blank Piston	4	\$5.25
RS-12		Slightly larger in diameter than the stock piston. The precise fit of the piston in the shock body reduces blow-by, allowing for more accurate shock tuning.	1.0mm hole x 2	4	\$5.25
RS-13		1.1mm hole x 2	4	\$5.25	
RS-14		1.2mm hole x 3	4	\$5.25	
RS-15		RAYSPEED Aluminum Spring Retainers Made of lightweight aluminum and blue anodized. For use with Yokomo Pro Shocks and 1" long springs .	Compatible with Rayspeed and Associated touring car springs	2	\$6.50
RS-16		RAYSPEED EXCEED Discharge Tray (Equalizer & Conditioner) Equalizes and conditions batteries for maximum performance. See page 18 for further details.	NiCd & NiMH compatible 5A equalizing mode 1A conditioning mode	1	\$69.50
RS-17		RAYSPEED Shock Piston (For the Associated RC10B4)		4	\$5.00
RS-18		RAYSPEED Front Shock Spring (For the Associated RC10B4)	Black	2	\$4.00
RS-19		RAYSPEED ULTIMATE Conversion Kit	For the MR-4TC SD SSG & BLACK		\$178.50
RS-20		RAYSPEED ULTIMATE Main Graphite Chassis		1	\$85.00
RS-21		RAYSPEED ULTIMATE Graphite Upper Deck		1	\$29.50
RS-22		RAYSPEED ULTIMATE Servo Saver Plate		1	\$30.75
RS-23		RAYSPEED ULTIMATE Graphite Shock Tower	Designed to use SS-size shocks	1	\$18.00
RS-24		RAYSPEED ULTIMATE Aluminum Motor Mount		1	\$37.50
RS-25		RAYSPEED Lower Anti-Roll Bar Set (For the MR-4TC SD)	Bars included: black, silver, gold, copper		\$9.00
RS-26		RAYSPEED ACCORD 190mm Body	Decals and window paint masking included.		\$21.95
RS-27		RAYSPEED Aluminum Rear Hub Carrier (0" Toe-In) For the Associated RC10B4		2	\$31.50
RS-28		RAYSPEED Aluminum Rear Hub Carrier (0.5" Toe-In) For the Associated RC10B4	Compatible with the Associated RC10B4	2	\$31.50
RS-29		RAYSPEED Aluminum Front Bulkhead For the Associated RC10B4		1	\$39.00
RS-30		RAYSPEED ULTIMATE Front Graphite Shock Tower	Designed to use SSS-size shocks	1	\$17.00
RS-31		RAYSPEED ULTIMATE Rear Graphite Shock Tower	Designed to use SSS-size shocks	1	\$23.00
RS-32		RAYSPEED Offroad Ride Height & Camber Gauge		1	\$27.00
RS-33		RAYSPEED MIP C.V.D. Front Universal Driveshafts For the MR-4TC SD	Aluminum bones	2	\$40.00
RS-34		RAYSPEED MIP C.V.D. Rear Universal Driveshafts For the MR-4TC SD	Aluminum bones	2	\$40.00

## UPGRADES FOR TEAM ASSOCIATED CARS

### RC10 TC3 PARTS

PART NO.	DESCRIPTION	QTY	PRICE
SP-3866	Hardened Suspension Hinge Pin Set		\$7.50
SP-3902	Aluminum Transponder Mount		\$13.00
SP-7369	Hardened Axle Pins	4	\$2.00
SP-3950C	Clamp Type Wheel Hubs (Blue)	2	\$9.50
SP-3938Y	Front One-Way Unit		\$59.00
SP-3966Y	Front One-Way Outdrives	2	\$9.50
SP-3967Y	Front One-Way Housing		\$42.50
SP-3938M	Front One-Way Maintenance Parts		\$2.75
SP-3938-6	HD Front One-Way		\$58.50
SP-3966-6	HD Front One-Way Outdrives	2	\$12.50
SP-3967-6	HD Front One-Way Housing		\$35.50
SP-3939-6	HD Front One-Way Ring Gear		\$5.00
SP-3976-6	HD Front One-Way Bearing		\$18.00
ZD-505T	Tungsten Carbide 3/32" Diff Balls	12	\$12.00
ZD-505C	Ceramic 3/32" Diff Balls	6	\$27.00

### RC10 NITRO TC3 PARTS

PART NO.	DESCRIPTION	QTY	PRICE
SP-7369	Hardened Axle Pins	4	\$2.00
SP-3950C	Clamp Type Wheel Hubs (Blue)	2	\$9.50
SP-MTCLA	MTC Racing Clutch Set		\$TBA
ZE-603L	Clutch Nut Shaft		\$8.00
ZE-609L	Clutch Shoe		\$8.00
ZE-609LG	Clutch Weights		\$5.25
ZE-609LP	Clutch Shoe Plate		\$10.50
ZE-609LC	Adjusting Nut & Spring Retainer		\$11.00
ZE-609LM	Clutch Spring		\$3.00
ZE-604L	Flywheel		\$28.50
ZE-610L	Clutch Bell		\$18.00
ZE-609MT	Thrust Bearing Shaft		\$5.50
TB-105	Thrust Bearing		\$8.50
ZE-600M	Engine Mount Set		\$24.25
SP-2296	Pinion Gear 20T (1st Gear)		\$TBA
SP-2300	Pinion Gear 21T (1st Gear)		\$TBA
SP-2299	Pinion Gear 26T (2nd Gear)		\$TBA
SP-2303	Pinion Gear 27T (2nd Gear)		\$TBA
SP-2235	Hardened Suspension Hinge Pin Set		\$7.50
SP-1717Y	Front Anti-Roll Bar Set		\$80.00
SP-1705Y	HD Front One-Way Unit		\$62.75
SP-1707Y	HD Front One-Way Outdrives		\$21.00
SP-3967-6	HD Front One-Way Housing		\$42.50
SP-3939-6	HD Front One-Way Ring Gear		\$5.00
SP-3976-6	HD Front One-Way Bearing		\$8.50
ZD-505T	Tungsten Carbide 3/32" Diff Balls	12	\$12.00
ZD-505C	Ceramic 3/32" Diff Balls	6	\$27.00



### RC12L4 PARTS

PART NO.	DESCRIPTION	QTY	PRICE
SP-1210-3	High Traction Rear Wheels	3 sets	\$8.50
SP-1250-3	High Traction Front Wheels	3 sets	\$7.50
SP-FLM	L Rubber Medium Front Tire (Pre-Mounted)		\$15.00
SP-FLF	L Rubber Firm Front Tire (Pre-Mounted)		\$15.00
SP-RLS	L Rubber Soft Rear Tire (Pre-Mounted)		\$19.00
SP-12MS1	MS-1 1/12th Scale Body		\$16.25
SP-12MS2	MS-2 1/12th Scale Body		\$16.25
SP-3323	Lower Suspension Arm Spacer (1.6mm)	4	\$9.50
SP-3323T	Lower Suspension Arm Spacer (0.8mm)	4	\$6.75
SP-3655S	Front Wheel Bearing (For JACO Wheels)	4	\$22.50
SP-4403H	Hardened King Pin	2	\$5.50
SP-8415	Titanium Turnbuckle (Upper A-Arm)	2	\$16.75





## SETTING TOOLS

PART NO.	DESCRIPTION	PRICE
YT-MSY	Maintenance Stand (Yellow)	\$25.00
YT-MSB	Maintenance Stand (Smoke)	\$25.00
YT-RSY	Racing Stand (Yellow)	\$18.50
YT-RSB	Racing Stand (Smoke)	\$18.50
YT-STBL	Setting Board L (457 × 360 × 8mm) Setting Board Decal Included	\$68.00
YT-STBLD	Setting Board Decal	\$6.00
YT-SGN	Setting Gauge (For GP Touring Cars)	\$145.00
YT-HDG	Ride Height and Droop Gauge	\$18.00
YT-RSWR	Racing Setting Wheels (Silver) 0 offset	\$42.00
YT-RSWRB	Racing Setting Wheels (Blue) 0 offset	\$47.00
YT-RSWO	Setting Wheel O Rings (4 Pieces)	\$TBA
YT-RSWN2	Setting Wheel Nut (Silver)	\$7.00
YT-RSWN	Setting Wheel Nut (Blue)	\$7.00
YT-PGHG	Pinion Gear Holder (Gun Metal)	\$24.75
YT-PGHB	Pinion Gear Holder (Blue)	\$24.75

## STORAGE CASES

PART NO.	DESCRIPTION	PRICE
YC-1	Parts Case (59 × 87 × 22mm)	\$18.75
YC-5	Parts Case (102 × 157 × 40mm)	\$8.00
YC-6	Parts Case (145 × 207 × 40mm)	\$13.25
YC-7	Parts Case (190 × 225 × 40mm)	\$20.50
YC-8	Parts Case (228 × 332 × 72mm)	\$26.00
YC-9	Parts Case (193 × 286 × 46mm)	\$24.00
YT-21BK	Carrying Bag (30 × 56 × 46cm)	\$70.00

## OTHER

PART NO.	DESCRIPTION	PRICE
YT-PM	Yokomo Pit Mat (Blue)	\$39.50
YT-PMBK	Yokomo Pit Mat (Black)	\$49.50
YT-RMP	Racing Mini Pylons (6 Pieces)	\$24.00

## TOOLS

PART NO.	DESCRIPTION	PRICE	PART NO.	DESCRIPTION	PRICE
YT-WDP1	Phillips Tip Screwdriver #1	\$20.00	ZM-TBL	Turnbuckle Wrench (For Steel Turnbuckles)	\$2.25
YT-WDP2	Phillips Tip Screwdriver #2	\$20.00	KLD-W	Turnbuckle Wrench (For Titanium Turnbuckles)	\$3.50
YT-WDM4	Flat Tip Screwdriver φ 4	\$20.00	3M-2L	Strapping Tape 12mm × 54.8m	\$21.00
YT-WDM5	Flat Tip Screwdriver φ 5	\$20.00	3M-2LW	Strapping Tape 19mm × 54.8m	\$33.00
YT-W150	Hex Tip Screwdriver 1.5mm	\$15.50	YT-WG	Tire Gluing Rubber Bands	\$1.00
YT-W200	Hex Tip Screwdriver 2.0mm	\$15.50	ZC-203	Double-Sided Tape	\$1.75
YT-W250	Hex Tip Screwdriver 2.5mm	\$15.50	ZC-203B	Heat Resistant Double-Sided Tape	\$3.50
YT-W127	Hex Tip Screwdriver 0.050"	\$15.50	RC-320	Double-Sided Foam Tire Mounting Tape	\$TBA
YT-W158	Hex Tip Screwdriver 1/16"	\$15.50			
YT-W238	Hex Tip Screwdriver 3/32"	\$15.50			
YT-1500	Pivot Nut Driver 5.0mm (Compatible with pivot nuts on most GP cars.)	\$18.25			
YT-1600	Pivot Nut Driver 6.0mm (For GT-4 Pivot Nut.)	\$18.25			
YT-WN50	Nut Driver 5.0mm (For ball Stud)	\$16.75			
YT-WN55	Nut Driver 5.5mm (For 3mm Nut)	\$16.75			
YT-WN70	Nut Driver 7.0mm (For 4mm Nut)	\$16.75			
YT-WN316	Nut Driver 3/16" (For 4-40 Small Nut)	\$16.75			
YT-WN140	Nut Driver 1/4" (For 4-40 Standard Nut)	\$16.75			
YT-WN1132	Nut Driver 11/32" (For 8-32 Nut)	\$16.75			
YT-BP25	Ball Hex Tip Wrench 2.5mm	\$3.50			
YT-300	Cross Wrench (5.0 · 5.5 · 7.0mm · Ball ends)	\$2.00			

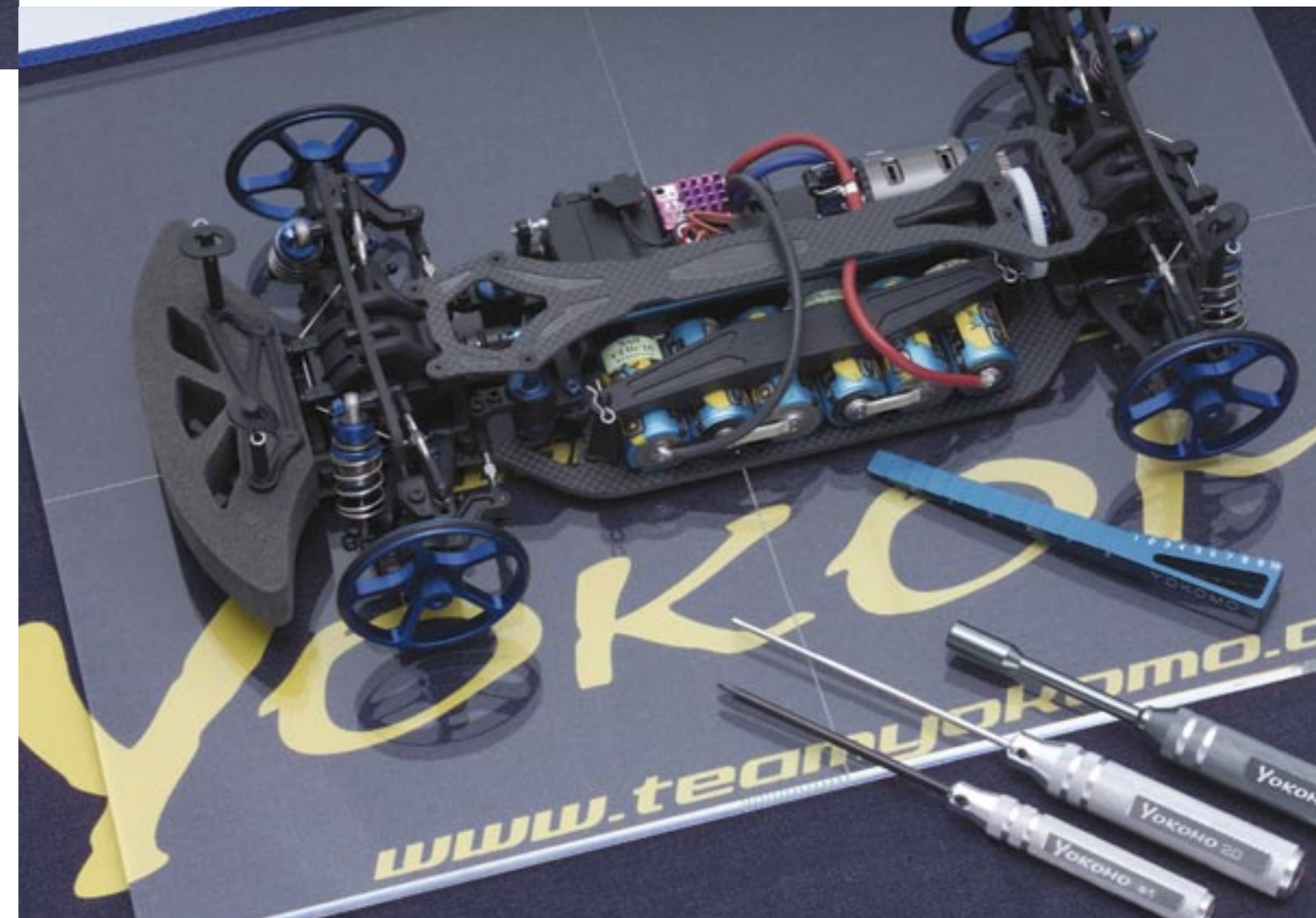

Manufacturer's Suggested Retail Prices listed. Contact your local Yokomo retailer for current prices.

SCREWS (mm)

PART NO.	DESCRIPTION	QTY	PRICE
			
ZC-F35	Flat Head Socket Screw M3 × 5mm	10	\$2.00
ZC-F36	Flat Head Socket Screw M3 × 6mm	10	\$2.00
ZC-F38	Flat Head Socket Screw M3 × 8mm	10	\$2.00
ZC-F310	Flat Head Socket Screw M3 × 10mm	10	\$2.00
ZC-F312	Flat Head Socket Screw M3 × 12mm	10	\$2.00
ZC-F314	Flat Head Socket Screw M3 × 14mm	10	\$2.00
ZC-F315	Flat Head Socket Screw M3 × 15mm	10	\$2.00
ZC-F316	Flat Head Socket Screw M3 × 16mm	10	\$2.00
ZC-F318	Flat Head Socket Screw M3 × 18mm	8	\$2.00
ZC-F320	Flat Head Socket Screw M3 × 20mm	8	\$2.00
ZC-F322	Flat Head Socket Screw M3 × 22mm	8	\$2.00
ZC-F325	Flat Head Socket Screw M3 × 25mm	8	\$2.00
ZC-F330	Flat Head Socket Screw M3 × 30mm	6	\$2.00
ZC-F335	Flat Head Socket Screw M3 × 35mm	4	\$2.00
ZC-F35T	Titanium Flat Head Socket Screw M3 × 5mm	5	\$5.75
ZC-F36T	Titanium Flat Head Socket Screw M3 × 6mm	5	\$5.75
ZC-F38T	Titanium Flat Head Socket Screw M3 × 8mm	5	\$5.75
ZC-F310T	Titanium Flat Head Socket Screw M3 × 10mm	5	\$5.75
ZC-F312T	Titanium Flat Head Socket Screw M3 × 12mm	4	\$5.75
ZC-F315T	Titanium Flat Head Socket Screw M3 × 15mm	4	\$5.75
ZC-F318T	Titanium Flat Head Socket Screw M3 × 18mm	4	\$7.00
ZC-F320T	Titanium Flat Head Socket Screw M3 × 20mm	4	\$7.00
ZC-F322T	Titanium Flat Head Socket Screw M3 × 22mm	4	\$7.00
ZC-F325T	Titanium Flat Head Socket Screw M3 × 25mm	3	\$7.00
ZC-F330T	Titanium Flat Head Socket Screw M3 × 30mm	2	\$7.00
ZC-F335T	Titanium Flat Head Socket Screw M3 × 35mm	2	\$7.00



ZC-BH35	Button Head Socket Screw M3 × 5mm	10	\$2.00
ZC-BH36	Button Head Socket Screw M3 × 6mm	10	\$2.00
ZC-BH38	Button Head Socket Screw M3 × 8mm	10	\$2.00
ZC-BH310	Button Head Socket Screw M3 × 10mm	10	\$2.00
ZC-BH312	Button Head Socket Screw M3 × 12mm	10	\$2.00
ZC-BH314	Button Head Socket Screw M3 × 14mm	10	\$2.00
ZC-BH315	Button Head Socket Screw M3 × 15mm	10	\$2.00
ZC-BH316	Button Head Socket Screw M3 × 16mm	10	\$2.00
ZC-BH318	Button Head Socket Screw M3 × 18mm	8	\$2.00
ZC-BH320	Button Head Socket Screw M3 × 20mm	8	\$2.00
ZC-BH322	Button Head Socket Screw M3 × 22mm	8	\$2.00
ZC-BH325	Button Head Socket Screw M3 × 25mm	8	\$2.00
ZC-BH330	Button Head Socket Screw M3 × 30mm	6	\$2.00
ZC-BH335	Button Head Socket Screw M3 × 35mm	4	\$2.00
ZC-BH35T	Titanium Button Head Socket Screw M3 × 5mm	5	\$5.75
ZC-BH36T	Titanium Button Head Socket Screw M3 × 6mm	5	\$5.75
ZC-BH38T	Titanium Button Head Socket Screw M3 × 8mm	5	\$5.75
ZC-BH310T	Titanium Button Head Socket Screw M3 × 10mm	5	\$5.75
ZC-BH312T	Titanium Button Head Socket Screw M3 × 12mm	4	\$5.75
ZC-BH315T	Titanium Button Head Socket Screw M3 × 15mm	4	\$5.75
ZC-BH318T	Titanium Button Head Socket Screw M3 × 18mm	4	\$7.00
ZC-BH320T	Titanium Button Head Socket Screw M3 × 20mm	4	\$7.00
ZC-BH322T	Titanium Button Head Socket Screw M3 × 22mm	4	\$7.00
ZC-BH325T	Titanium Button Head Socket Screw M3 × 25mm	3	\$7.00
ZC-BH330T	Titanium Button Head Socket Screw M3 × 30mm	2	\$7.00
ZC-BH335T	Titanium Button Head Socket Screw M3 × 35mm	2	\$7.00









SET SCREWS (mm)

PART NO.	DESCRIPTION	QTY	PRICE
ZC-SS33	Set Screw M3 × 3mm	10	\$1.25
ZC-SS34	Set Screw M3 × 4mm	10	\$1.25
ZC-SS310	Set Screw M3 × 10mm	10	\$1.50
ZC-SS312	Set Screw M3 × 12mm	10	\$1.50

NUTS (mm)

PART NO.	DESCRIPTION	QTY	PRICE
ZC-N4AFB	Aluminum Flanged Nylon Lock Nut 4mm (Blue)	4	\$4.25
ZC-N3A	Aluminum Nylon Lock Nut 3mm	10	\$5.25
ZC-N3T	Titanium Nylon Lock Nut 3mm	4	\$12.25
ZC-N3AB	Aluminum Nylon Lock Nut 3mm (Blue)	4	\$3.00
ZC-N3AP	Aluminum Hex Nut 3mm	10	\$2.00
ZC-N3APB	Aluminum Hex Nut 3mm (Blue)	4	\$2.00
ZC-N3TP	Titanium Hex Nut 3mm	4	\$7.25

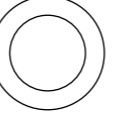

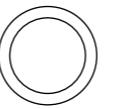

SPACER SHIMS (mm)

PART NO.	DESCRIPTION	QTY	PRICE
ZC-S20	Spacer Shim 2.0mm ID (0.13 · 0.25 · 0.50mm thick)	 20	\$4.75
ZC-S25	Spacer Shim 2.5mm ID (0.13 · 0.25 · 0.50mm thick)	 20	\$4.75
ZC-S30	Spacer Shim 3.0mm ID (0.13 · 0.25 · 0.50mm thick)	 20	\$4.75
ZC-S40	Spacer Shim 4.0mm ID (0.13 · 0.25 · 0.50mm thick)	 20	\$4.75
ZC-S50	Spacer Shim 5.0mm ID (0.13 · 0.25 · 0.50mm thick)	 20	\$4.75
ZC-S60	Spacer Shim 6.0mm ID (0.13 · 0.25 · 0.50mm thick)	 20	\$4.75
ZC-S100	Spacer Shim 10.0mm ID (0.13 · 0.25 · 0.50mm thick)	 10	\$4.75
ZC-S50S	Stainless Steel Spacer Shim 5.0mm ID (0.05 · 0.10 · 0.20mm thick)	 10	\$4.50
ZC-S80S	Stainless Steel Spacer Shim 8.0mm ID (0.05 · 0.10 · 0.20mm thick)	 10	\$4.50
ZC-S100S	Stainless Steel Spacer Shim 10.0mm ID (0.05 · 0.10 · 0.20mm thick)	 10	\$4.50

TURNBUCKLES (mm)

PART NO.	DESCRIPTION	QTY	PRICE
			
ZM-TB20	Steel Turnbuckle 20mm	2	\$2.00
ZM-TB25	Steel Turnbuckle 25mm	2	\$3.00
ZM-TB33	Steel Turnbuckle 33mm	2	\$3.00
ZM-TB36	Steel Turnbuckle 36mm	2	\$3.00
ZM-TB42	Steel Turnbuckle 42mm	2	\$3.00
ZM-TB48	Steel Turnbuckle 48mm	2	\$3.00
ZM-TB52	Steel Turnbuckle 52mm	2	\$3.00
ZC-TB16	Titanium Turnbuckle 16mm	2	\$14.75
ZC-TB18	Titanium Turnbuckle 18mm	2	\$14.75
ZC-TB20	Titanium Turnbuckle 20mm	2	\$14.75
ZC-TB25	Titanium Turnbuckle 25mm	2	\$14.75
ZC-TB27	Titanium Turnbuckle 27mm	2	\$14.75
ZC-TB29	Titanium Turnbuckle 29mm	2	\$14.75
ZC-TB33	Titanium Turnbuckle 33mm	2	\$14.75
ZC-TB36	Titanium Turnbuckle 36mm	2	\$14.75
ZC-TB39	Titanium Turnbuckle 39mm	2	\$14.75
ZC-TB42	Titanium Turnbuckle 42mm	2	\$14.75
ZC-TB45	Titanium Turnbuckle 45mm	2	\$14.75
ZC-TB48	Titanium Turnbuckle 48mm	2	\$14.75
ZC-TB50	Titanium Turnbuckle 50mm	2	\$14.75
ZC-TB52	Titanium Turnbuckle 52mm	2	\$14.75
ZC-TB55	Titanium Turnbuckle 55mm	2	\$14.75
ZC-TB58	Titanium Turnbuckle 58mm	2	\$14.75
ZC-TB60	Titanium Turnbuckle 60mm	2	\$14.75
ZC-TB62	Titanium Turnbuckle 62mm	2	\$14.75
ZC-TB65	Titanium Turnbuckle 65mm	2	\$14.75
ZC-TB67	Titanium Turnbuckle 67mm	2	\$14.75
ZC-TB90	Titanium Turnbuckle 90mm	2	\$14.75

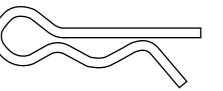
OTHER

PART NO.	DESCRIPTION	QTY	PRICE
RC-313S	Body Clip (S)	 12	\$1.25
RC-313M	Body Clip (M)	 10	\$1.25
RC-313L	Body Clip (L)	 10	\$2.00
ZC-120S	Racing Body Clip (Locking Type)	 8	\$2.75
ZR-200A	Black Antenna Set		\$1.75
ZR-200C	Antenna Cap		\$1.50
ZR-200H	Antenna Holder		\$1.75
YT-RW510	Racing Weights (5g × 4 · 10g × 4)		\$3.25





## CHEMICALS

PART NO.	DESCRIPTION	PRICE
CS-C	Super Cleaner High strength spray cleaner for motors, bearings, and metal parts. (420g)	\$13.00
CS-B	Super Blow Pressurized air for blowing off dirt and dust. (450g)	\$23.00
CS-DP	Super Dry Powder Lubricant Spray lubricant. Great for use on hinge pins. (100ml)	\$14.50
CS-M	Commutator Conditioner Conditions motor commutator to look like new. (20ml)	\$9.50
CS-SDL	Associated Stealth Diff Lube Recommended lube for ball differentials. (4cc)	\$2.50
CS-SBG	Associated Black Grease Recommended for differential thrust bearings. (4cc)	\$2.50
CS-TC1	Tire Conditioner Rubber tire cleaner. (420ml)	\$TBA
CS-TC2	Tire Conditioner (Economy Size) Rubber tire cleaner. (720ml)	\$17.00
CS-SG	Super Tire Glue (Medium) Fast drying high strength glue for r/c rubber tires. (20g)	\$9.50
CS-SGT	Super Tire Glue (Thin) Fast drying high strength glue for r/c rubber tires. (20g)	\$9.50
YT-ON	Tire Glue Bottle Nozzle (6 pieces)	\$1.50
CS-SP	Super Accelerator Aerosol spray CA glue accelerator.	\$11.50
CS-NC	Nano Carbon RC Contact Enhancer Improves conductivity of motor and battery connectors.	\$22.50
CS-F0	F-ZERO Oil Spray Lubricant Spray lubricant for bearings.	\$32.50

## SHOCK OILS

PART NO.	DESCRIPTION	PRICE
Shock oil is used in the shocks to help dissipate energy stored by the spring, and to keep the suspension from bouncing out of control. The number in parentheses indicates viscosity. A higher number indicates thicker oil.		
YS-150	Super Blend Shock Oil (#150)	\$5.75
YS-200	Super Blend Shock Oil (#200)	\$5.75
YS-250	Super Blend Shock Oil (#250)	\$5.75
YS-300	Super Blend Shock Oil (#300)	\$5.75
YS-350	Super Blend Shock Oil (#350)	\$5.75
YS-400	Super Blend Shock Oil (#400)	\$5.75
YS-450	Super Blend Shock Oil (#450)	\$5.75
YS-500	Super Blend Shock Oil (#500)	\$5.75
YS-550	Super Blend Shock Oil (#550)	\$5.75
YS-600	Super Blend Shock Oil (#600)	\$5.75
YS-650	Super Blend Shock Oil (#650)	\$5.75
YS-700	Super Blend Shock Oil (#700)	\$5.75

## GENERAL-PURPOSE PARTS

### PINION GEARS

PART NO.	DESCRIPTION	PRICE
Machined using the latest precision equipment for maximum accuracy and light weight, these gears are hard coated for unsurpassed durability.		
PG-4816	Hard Coated Precision Pinion Gear 48 Pitch 16T	\$7.00
PG-4817	Hard Coated Precision Pinion Gear 48 Pitch 17T	\$7.00
PG-4818	Hard Coated Precision Pinion Gear 48 Pitch 18T	\$7.00
PG-4819	Hard Coated Precision Pinion Gear 48 Pitch 19T	\$7.00
PG-4820	Hard Coated Precision Pinion Gear 48 Pitch 20T	\$7.00
PG-4821	Hard Coated Precision Pinion Gear 48 Pitch 21T	\$7.00
PG-4822	Hard Coated Precision Pinion Gear 48 Pitch 22T	\$7.00
PG-4823	Hard Coated Precision Pinion Gear 48 Pitch 23T	\$7.00
PG-4824	Hard Coated Precision Pinion Gear 48 Pitch 24T	\$7.00
PG-4825	Hard Coated Precision Pinion Gear 48 Pitch 25T	\$7.00
PG-4826	Hard Coated Precision Pinion Gear 48 Pitch 26T	\$7.00
PG-4827	Hard Coated Precision Pinion Gear 48 Pitch 27T	\$7.00
PG-4828	Hard Coated Precision Pinion Gear 48 Pitch 28T	\$7.00
PG-4829	Hard Coated Precision Pinion Gear 48 Pitch 29T	\$7.00
PG-4830	Hard Coated Precision Pinion Gear 48 Pitch 30T	\$7.00
PG-4831	Hard Coated Precision Pinion Gear 48 Pitch 31T	\$7.00
PG-4832	Hard Coated Precision Pinion Gear 48 Pitch 32T	\$7.00
PG-4833	Hard Coated Precision Pinion Gear 48 Pitch 33T	\$7.00
PG-4834	Hard Coated Precision Pinion Gear 48 Pitch 34T	\$7.00
PG-4835	Hard Coated Precision Pinion Gear 48 Pitch 35T	\$7.00
PG-4836	Hard Coated Precision Pinion Gear 48 Pitch 36T	\$7.00
PG-4837	Hard Coated Precision Pinion Gear 48 Pitch 37T	\$7.00
PG-4838	Hard Coated Precision Pinion Gear 48 Pitch 38T	\$7.00
PG-4839	Hard Coated Precision Pinion Gear 48 Pitch 39T	\$7.00
PG-4840	Hard Coated Precision Pinion Gear 48 Pitch 40T	\$7.00
PG-6422	Hard Coated Precision Pinion Gear 64 Pitch 22T	\$7.00
PG-6423	Hard Coated Precision Pinion Gear 64 Pitch 23T	\$7.00
PG-6424	Hard Coated Precision Pinion Gear 64 Pitch 24T	\$7.00
PG-6425	Hard Coated Precision Pinion Gear 64 Pitch 25T	\$7.00
PG-6426	Hard Coated Precision Pinion Gear 64 Pitch 26T	\$7.00
PG-6427	Hard Coated Precision Pinion Gear 64 Pitch 27T	\$7.00
PG-6428	Hard Coated Precision Pinion Gear 64 Pitch 28T	\$7.00
PG-6429	Hard Coated Precision Pinion Gear 64 Pitch 29T	\$7.00
PG-6430	Hard Coated Precision Pinion Gear 64 Pitch 30T	\$7.00
PG-6431	Hard Coated Precision Pinion Gear 64 Pitch 31T	\$7.00
PG-6432	Hard Coated Precision Pinion Gear 64 Pitch 32T	\$7.00
PG-6433	Hard Coated Precision Pinion Gear 64 Pitch 33T	\$7.00
PG-6434	Hard Coated Precision Pinion Gear 64 Pitch 34T	\$7.00
PG-6435	Hard Coated Precision Pinion Gear 64 Pitch 35T	\$7.00
PG-6436	Hard Coated Precision Pinion Gear 64 Pitch 36T	\$7.00
PG-6437	Hard Coated Precision Pinion Gear 64 Pitch 37T	\$7.00
PG-6438	Hard Coated Precision Pinion Gear 64 Pitch 38T	\$7.00
PG-6439	Hard Coated Precision Pinion Gear 64 Pitch 39T	\$7.00
PG-6440	Hard Coated Precision Pinion Gear 64 Pitch 40T	\$7.00
PG-6441	Hard Coated Precision Pinion Gear 64 Pitch 41T	\$7.00
PG-6442	Hard Coated Precision Pinion Gear 64 Pitch 42T	\$7.00
PG-6443	Hard Coated Precision Pinion Gear 64 Pitch 43T	\$7.00
PG-6444	Hard Coated Precision Pinion Gear 64 Pitch 44T	\$7.00
PG-6445	Hard Coated Precision Pinion Gear 64 Pitch 45T	\$7.00
PG-6446	Hard Coated Precision Pinion Gear 64 Pitch 46T	\$7.00
PG-6447	Hard Coated Precision Pinion Gear 64 Pitch 47T	\$7.00
PG-6448	Hard Coated Precision Pinion Gear 64 Pitch 48T	\$7.00
PG-6449	Hard Coated Precision Pinion Gear 64 Pitch 49T	\$7.00
PG-6450	Hard Coated Precision Pinion Gear 64 Pitch 50T	\$7.00

Perfect for organizing pinion gears !!

YT-PGHB	Pinion Gear Holder (Blue)	\$24.75
YT-PGHG	Pinion Gear Holder (Gun Metal)	\$24.75
The correct tool for removing the pinion gear set screw.		
YT-W150	Hex Tip Screwdriver 1.5mm	\$15.50

Manufacturer's Suggested Retail Prices listed. Contact your local Yokomo retailer for current prices.

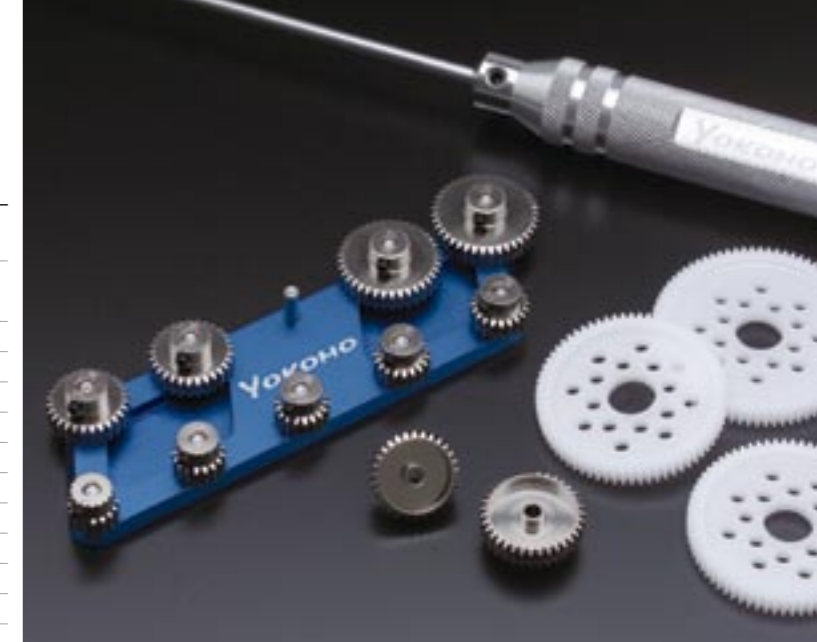

### SPUR GEARS

PART NO.	DESCRIPTION	PRICE
SG-4868	Precision Spur Gear 48 Pitch 68T	\$5.00
SG-4869	Precision Spur Gear 48 Pitch 69T	\$5.00
SG-4870	Precision Spur Gear 48 Pitch 70T	\$5.00
SG-4871	Precision Spur Gear 48 Pitch 71T	\$5.00
SG-4872	Precision Spur Gear 48 Pitch 72T	\$5.00
SG-4877	Precision Spur Gear 48 Pitch 77T	\$5.00
SG-4878	Precision Spur Gear 48 Pitch 78T	\$5.00
SG-4879	Precision Spur Gear 48 Pitch 79T	\$5.00
SG-4880	Precision Spur Gear 48 Pitch 80T	\$5.00
SG-4881	Precision Spur Gear 48 Pitch 81T	\$5.00
SG-4882	Precision Spur Gear 48 Pitch 82T	\$5.00
SG-4883	Precision Spur Gear 48 Pitch 83T	\$5.00
SG-4884	Precision Spur Gear 48 Pitch 84T	\$5.00
SG-6488	Precision Spur Gear 64 Pitch 88T	\$5.00
SG-6489	Precision Spur Gear 64 Pitch 89T	\$5.00
SG-6490	Precision Spur Gear 64 Pitch 90T	\$5.00
SG-6491	Precision Spur Gear 64 Pitch 91T	\$5.00
SG-6492	Precision Spur Gear 64 Pitch 92T	\$5.00
SG-6493	Precision Spur Gear 64 Pitch 93T	\$5.00
SG-6494	Precision Spur Gear 64 Pitch 94T	\$5.00
SG-6498	Precision Spur Gear 64 Pitch 98T	\$5.00
SG-6499	Precision Spur Gear 64 Pitch 99T	\$5.00
SG-64100	Precision Spur Gear 64 Pitch 100T	\$5.00
SG-64101	Precision Spur Gear 64 Pitch 101T	\$5.00
SG-64102	Precision Spur Gear 64 Pitch 102T	\$5.00
SG-64103	Precision Spur Gear 64 Pitch 103T	\$5.00
SG-64104	Precision Spur Gear 64 Pitch 104T	\$5.00
SG-64105	Precision Spur Gear 64 Pitch 105T	\$5.00
SG-64106	Precision Spur Gear 64 Pitch 106T	\$5.00
SG-64107	Precision Spur Gear 64 Pitch 107T	\$5.00
SG-64108	Precision Spur Gear 64 Pitch 108T	\$5.00
SG-64109	Precision Spur Gear 64 Pitch 109T	\$5.00
SG-64110	Precision Spur Gear 64 Pitch 110T	\$5.00
SG-64111	Precision Spur Gear 64 Pitch 111T	\$5.00
SG-64112	Precision Spur Gear 64 Pitch 112T	\$5.00

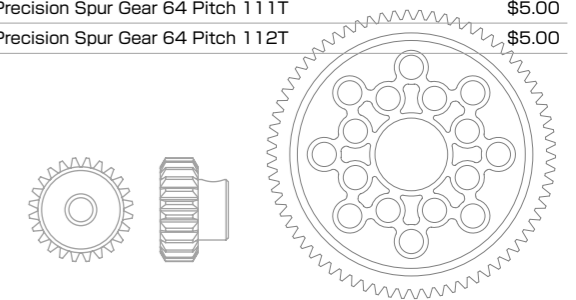

BALL BEARINGS (mm)

PART NO.	DESCRIPTION	QTY	PRICE	APPLICATION
BB-84-2	Ball Bearing $\phi 8 \times \phi 4 \times 3\text{mm}$	2	\$7.00	MR-4TC SD (Servo Saver)
BB-84-4		4	\$12.75	MR-4 Series (Center Shaft, Belt Tensioner, Servo Saver)
BB-840P	Super Precision Ball Bearing $\phi 8 \times \phi 4 \times 3\text{mm}$	2	\$8.50	GT-4 (Belt Tensioner)
BB-85-4	Ball Bearing $\phi 8 \times \phi 5 \times 2.5\text{mm}$ (9 balls used)	4	\$13.75	
BB-850P	Super Precision Ball Bearing $\phi 8 \times \phi 5 \times 2.5\text{mm}$ (13 balls used)	2	\$11.50	MR-4TC SD (Diff Internal) MR-4 Series (Diff Internal)
BB-850C2	Ceramic Ball Bearing $\phi 8 \times \phi 5 \times 2.5\text{mm}$	2	\$21.25	
BB-106-2	Ball Bearing $\phi 10 \times \phi 6 \times 3\text{mm}$	2	\$6.75	
BB-106-4		4	\$13.50	
BB-106T-2	Teflon Sealed Ball Bearing $\phi 10 \times \phi 6 \times 3\text{mm}$	2	\$9.00	MR-4TC SD (Axle)
BB-106T-4		4	\$18.00	MR-4 Series (Axle)
BB-1060P	Super Precision Ball Bearing $\phi 10 \times \phi 6 \times 3\text{mm}$	2	\$11.50	
BB-106C2	Ceramic Ball Bearing $\phi 10 \times \phi 6 \times 3\text{mm}$	2	\$21.00	
ZC-417R	Ball Bearing $\phi 11 \times \phi 5 \times 4\text{mm}$	2	\$8.25	
ZC-416R		4	\$16.25	YR-4 Series (Axle)
BB-115C2	Ceramic Ball Bearing $\phi 11 \times \phi 5 \times 4\text{mm}$	2	\$20.00	
BB-126-2	Ball Bearing $\phi 12 \times \phi 6 \times 4\text{mm}$	2	\$9.50	
BB-126-4		4	\$18.50	MR-4 Series (HD Rear Hub Carrier) GT-4 Series (Center & Middle Layshaft_)
BB-126C	Ceramic Ball Bearing $\phi 12 \times \phi 6 \times 4\text{mm}$	1	\$10.00	
BB-126N-2	Ball Bearing $\phi 12 \times \phi 6 \times 3.5\text{mm}$	2	\$9.50	MR-4 Series (HD Steering Block)
BB-126N-4		4	\$18.00	
BB-128C2	Ceramic Ball Bearing $\phi 12 \times \phi 8 \times 3.5\text{mm}$	2	\$25.50	
BB-1510	Ball Bearing $\phi 15 \times \phi 10 \times 4\text{mm}$ (11 balls used)	2	\$11.75	
BB-1510T	Teflon Sealed Ball Bearing $\phi 15 \times \phi 10 \times 4\text{mm}$ (11 balls used)	2	\$16.50	MR-4TC SD (Transmission) MR-4 Series · YR-4 Series (Bulkhead)
BB-1510P	Super Precision Ball Bearing $\phi 15 \times \phi 10 \times 4\text{mm}$ (13 balls used)	2	\$10.75	GT-4 Series (F&R Hub Carrier, Bulkhead)
BB-1510C2	Ceramic Ball Bearing $\phi 15 \times \phi 10 \times 4\text{mm}$ (13 balls used)	2	\$26.00	
BB-105-2	Ball Bearing $\phi 10 \times \phi 5 \times 4\text{mm}$	2	\$9.50	
BB-1050P	Super Precision Ball Bearing $\phi 10 \times \phi 5 \times 4\text{mm}$	2	\$9.50	MR-4TC SD (Transmission) GT-4 Series (Clutch Bell)
BB-105C2	Ceramic Ball Bearing $\phi 10 \times \phi 5 \times 4\text{mm}$	2	\$19.00	
BB-1480-2	Ball Bearing $\phi 14 \times \phi 8 \times 4\text{mm}$	2	\$8.75	
BB-1480P	Super Precision Ball Bearing $\phi 14 \times \phi 8 \times 4\text{mm}$	2	\$9.50	MR-4TC SD (Transmission)
BB-148C2	Ceramic Ball Bearing $\phi 14 \times \phi 8 \times 4\text{mm}$	2	\$20.50	
SD-BBP	Super Precision Ball Bearing Set For the MR-4TC SD	23	\$64.50	
SD-BBC	Ceramic Ball Bearing Set For the MR-4TC SD	19	\$121.00	85 × 2 · 105 × 3 · 106 × 8 148 × 2 · 1510 × 4

\* The ceramic ball bearings are lubricated with oil, not grease. Cleaning out this oil and replacing it with a very low-friction oil such as F-ZERO will help enhance performance.



DIFF BALLS / THRUST BALLS

PART NO.	DESCRIPTION	QTY	PRICE	APPLICATION		
ZD-505		Standard	24	\$1.75		
ZD-505T	Diff Ball 3/32"	○	Tungsten (Durable)	12	\$12.00	MR-4 Series
ZD-505C		Ceramic (Super Durable)	6	\$27.00		
ZC-505	Diff Ball 1/8"	○	Standard	24	\$1.75	YR-4 Series (Using 33T pulleys) · YRX-2000, YRX-12WE
ZS-507		Standard		\$3.00	MR-4 Series (Thrust washers included)	
ZC-507	Thrust Ball 1/16"	○	Standard		\$3.00	YR-4 Series (Thrust washers included)
ZC-507T		Tungsten (Durable)	16	\$11.00	MR-4 Series, YR-4 Series	

DECALS

PART NO.	DESCRIPTION	PRICE	PART NO.	DESCRIPTION	PRICE
ZS-DMBW	YOKOMO Type-M Decal (Black with white outline) * Dry transfer type. Compared to traditional decals, the slightly raised lettering stands out more clearly. May not adhere well to sharp edges.	\$7.25	ZC-D12	<b>NEW Metallic Decals !!</b> YOKOMO Chrome Decals * Included in DRIFT PACKAGE STREET VERSION kits.	\$6.50
ZS-DMWB	YOKOMO Type-M Decal (White with black outline) * Dry transfer type. Compared to traditional decals, the slightly raised lettering stands out more clearly. May not adhere well to sharp edges.	\$7.25	ZC-D12B	<b>NEW Metallic Decals !!</b> YOKOMO Blue Metallic Decals	\$6.50
ZS-DMNW	YOKOMO Type-M Decal (Blue with white outline) * Dry transfer type. Compared to traditional decals, the slightly raised lettering stands out more clearly. May not adhere well to sharp edges.	\$7.25	ZC-D12R	<b>NEW Metallic Decals !!</b> YOKOMO Red Metallic Decals	\$6.50
ZS-DMOB	YOKOMO Type-M Decal (Orange with black outline) * Dry transfer type. Compared to traditional decals, the slightly raised lettering stands out more clearly. May not adhere well to sharp edges.	\$7.25	SD-D1	MR-4TC SD Decal Sheet (White with black outline)	\$2.00
			ZE-D1	GT-4 Logo Decals (Assorted black and silver)	\$3.50















# GT-4 RTR II

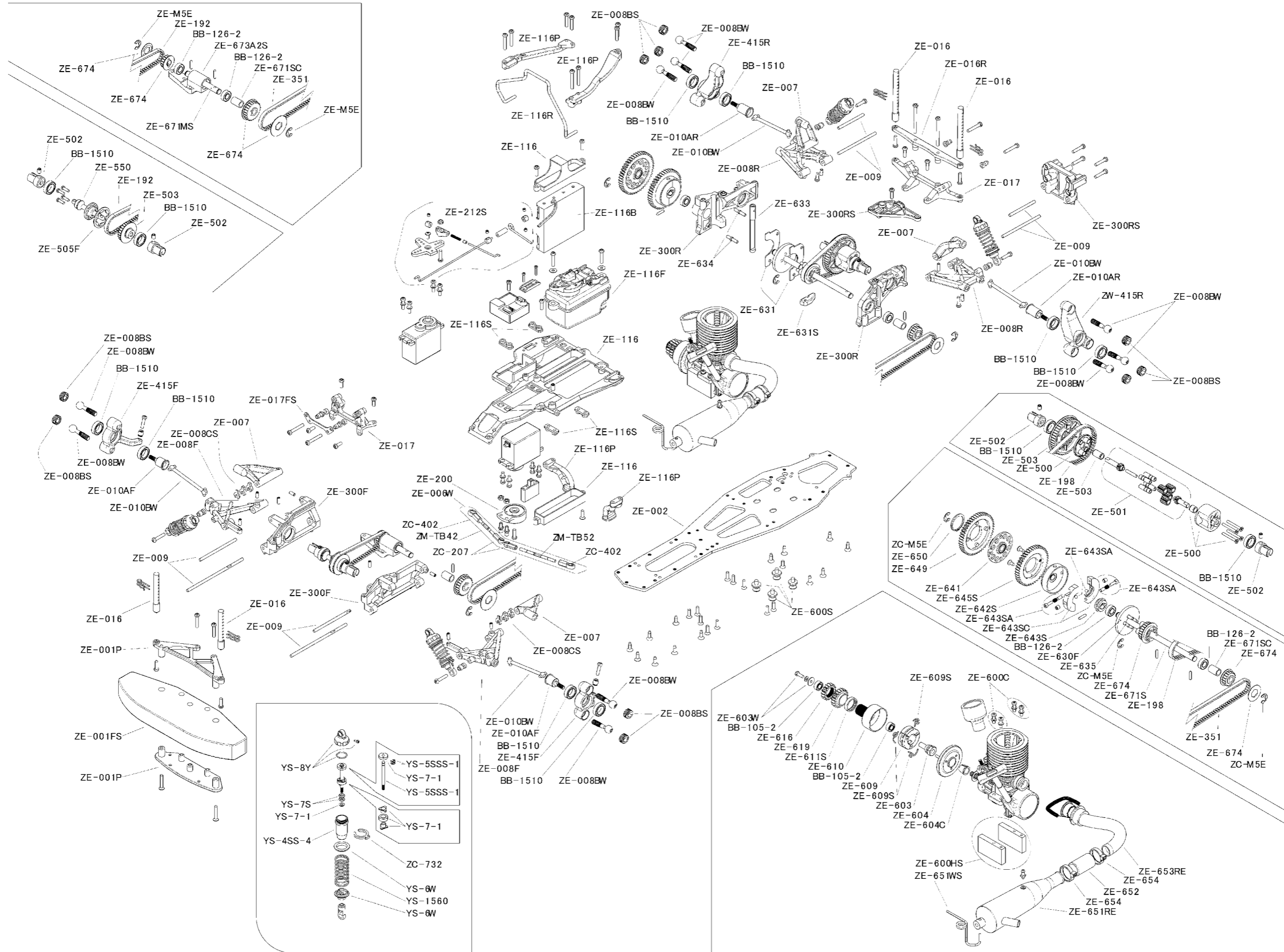

## ABOUT YOKOMO

### HOW IT ALL BEGAN

Yokomo originated as a radio control hobby store, the Yokobori Model Shop in Tokyo, Japan. Yokomo was derived from "Yoko" as in Yokobori (the family name) and "mo" as in Mokei, which is Japanese for models.

In 1965 Yokomo created what was very likely the first true radio controlled RTR, a converted .049 powered Cox Dune Buggy with one servo and a 3 channel Futaba system. Our RTR Buggy instantly became popular and introduced RC cars to Japan.

In 1970 we introduced the 1:8th scale Associated RC-1 to Japanese RC enthusiasts. Soon we began making option parts for the Associated cars, and to this day we continue to promote and support the Associated line of RC cars in Japan.

One thing is certain. Today the Yokomo name can be found on Championship trophies all over the world.

From humble origins a racing dynasty emerged, with cars bearing the Yokomo name winning 10 IFMAR World Championships, and countless National Championships.

### RACERS FROM THE START

1977 was the year Yokomo introduced our first competition kit, the Mini Racer RC12. If you happen have one, it is a genuine collectors item, since the car was never imported into the States. More importantly, the Mini Racer confirmed our intent to become a race car constructor. From that time, Yokomo kits would be designed with competition performance paramount.



MINI RACER RC-12 WITH 917-30KL BODY

Next came the YZ-834B in 1983. This 1:10 scale, 4WD Off Road missile was driven by Gil Losi Jr. to victory in the very first IFMAR Off Road Modified Class World Championships in 1987.

The success of this original Dogfighter confirmed our belief that the pursuit of excellence, use of only the finest, leading edge materials and traditional craftsmanship would be the trademark of all that carry the Yokomo name.

### THE DOGFIGHTER

Our engineering team really got their chance to shine up those trophies when our first Dogfighters tore up the racing circuit.

The YZ-834B and legendary YZ10 introduced a generation of RC racers to the incredible speed and performance of 4WD, electric off road buggies. From the time these first Yokomo cars hit the track, RC competition changed forever. And we are still teaching the old Dog new tricks, our newest MR-4BCS is a European and Japanese National Champion and will be gunning for our 11th World Championship overall, an unprecedented 7th in its class.

### YOKOMO USA - WHERE IT ALL COMES TOGETHER

Yokomo USA in California is the newest member of the family, which has expanded from our first hobby shop to include manufacturing of championship-winning RC car kits and race-bred RTRs, Yatabe Arena and Japanese distribution for Associated and other imported fine RC products.

With a line of products that now includes our new MR-4TC SD 1:10 electric touring car, MR-4TC MINI 1:12 electric touring car, the MR-4BCS 1:10 4WD offroad buggy and the GT-4 series of 1:10 nitro touring cars, Yokomo USA is committed to providing the same high level of quality to customer service and technical support that you demand.

Go to the track with Yokomo and you will see that we make model cars for real racers.



1965	First RC RTR
1977	Mini Racer RC-12
1979	Mini Racer RC-12 USA
1983	YZ-834B
1988	YZ-870C
1992	Works 93, Y-10
1993	YR-4 (Touring car)
	YZ-10
1994	YR-4GP
1995	YR-4 Special
	YR-4 Sports
	YR-4 GP EV
	YR-4M (Masami version)
	YRF-2 (FWD)
1996	YRF-2 Special
	YR-4II Compact
1997	Yokomo USA opens
	YR-4M2
	YR-4II Special
1998	MX-4
	YR-4J Racer
	YRX-10W
	YR-4M2 Type-J Pro
	YR-4M2 US
1999	MR-4 Rally
	MR-4TC
	MR-4TC Sports
	MR-4TC V-spec
	MR-4BC
	MR-4TC Pro
	MR-4MT
2000	MR-4TC R
	GT-4
	GT-4W
	YRX-2000
	MR-4TC WC Replica
2001	GT-4W US
	MR-4TC Special
	GT-4R
2002	YRX-12WE
	MR-4TC Euro Truck
	GT-4 RTR
2003	GT-4RTRII
	MR-4TC SD SSG
	MR-4TC SD BLACK
	MR-4TC Mini
	MR-4BC Special
	GT-4W Ver.2 Limited
	DRIFT PACKAGE
2004	MR-4TC SD CGM
	MR-4TC SD World's Replica



## ADDITIONAL INFORMATION

### WHERE TO BUY

If you want to know more about a specific Yokomo product, or the location of the Yokomo dealer nearest you, visit our website at [www.yokomousa.com](http://www.yokomousa.com) or call **1-949-252-8663**.

You can also contact the following RC hobby distributors for the location of a Yokomo dealer near you.

Horizon Hobby	1-877-504-0233
Great Planes	1-800-637-7660
ERI Associates	1-845-268-5090
GHI Distribution	1-714-921-0322
Global Hobby Distributors	1-714-964-0827
RCS	1-408-943-0874

### NEW PRODUCTS

Keep up to date on the latest Yokomo news and products by visiting our website at [www.yokomousa.com](http://www.yokomousa.com).

### TECHNICAL SUPPORT

When you buy a Yokomo product, you also get specialized service and support, because we understand that in order to get to the winners circle, sometimes it takes more than just a fast car and top-notch equipment. Count on our knowledgeable staff to keep you up to date with the latest tech advice from our championship winning team drivers and experts. Call or email us with your questions, we've got the answers.

### HOW TO ORDER

You can order by phone, or online via our web site, but kits must be ordered through your local hobby dealer. You cannot order car kits from Yokomo (with the exception of discontinued kits). Unless listed as a specially priced item, prices are set at full retail. Your local hobby shop may actually have lower prices. We encourage you to support your local hobby shop.

### CATALOG UPDATES

Product prices, descriptions and specifications listed in this catalog are subject to change without notice.

### DEALER RESOURCES

Looking for a distributor in the USA? Please see the above listing.

Want to have your hobby shop listed on our online Dealer Locator list? Email [sales@yokomousa.com](mailto:sales@yokomousa.com) or call **1-949-252-8663**.

### WANT TO BE A DISTRIBUTOR?

If you want to be a Distributor for Yokomo USA, email [sales@yokomousa.com](mailto:sales@yokomousa.com) or call us at **1-949-252-8663** and speak with our Sales department.

### CONTACT INFORMATION

Mailing address:	Yokomo USA, Inc. 17951 Skypark Circle Suite K Irvine, CA 92614 U.S.A.
Telephone	1-949-252-8663
Facsimile	1-949-252-8657
Internet	<a href="http://www.yokomousa.com">http://www.yokomousa.com</a>
Sales	<a href="mailto:sales@yokomousa.com">sales@yokomousa.com</a>
Technical Support	<a href="mailto:support@yokomousa.com">support@yokomousa.com</a>



